

## Hekwerkonline Comfort Buitenverblijf 500x270

Maat- en montagetekeningen

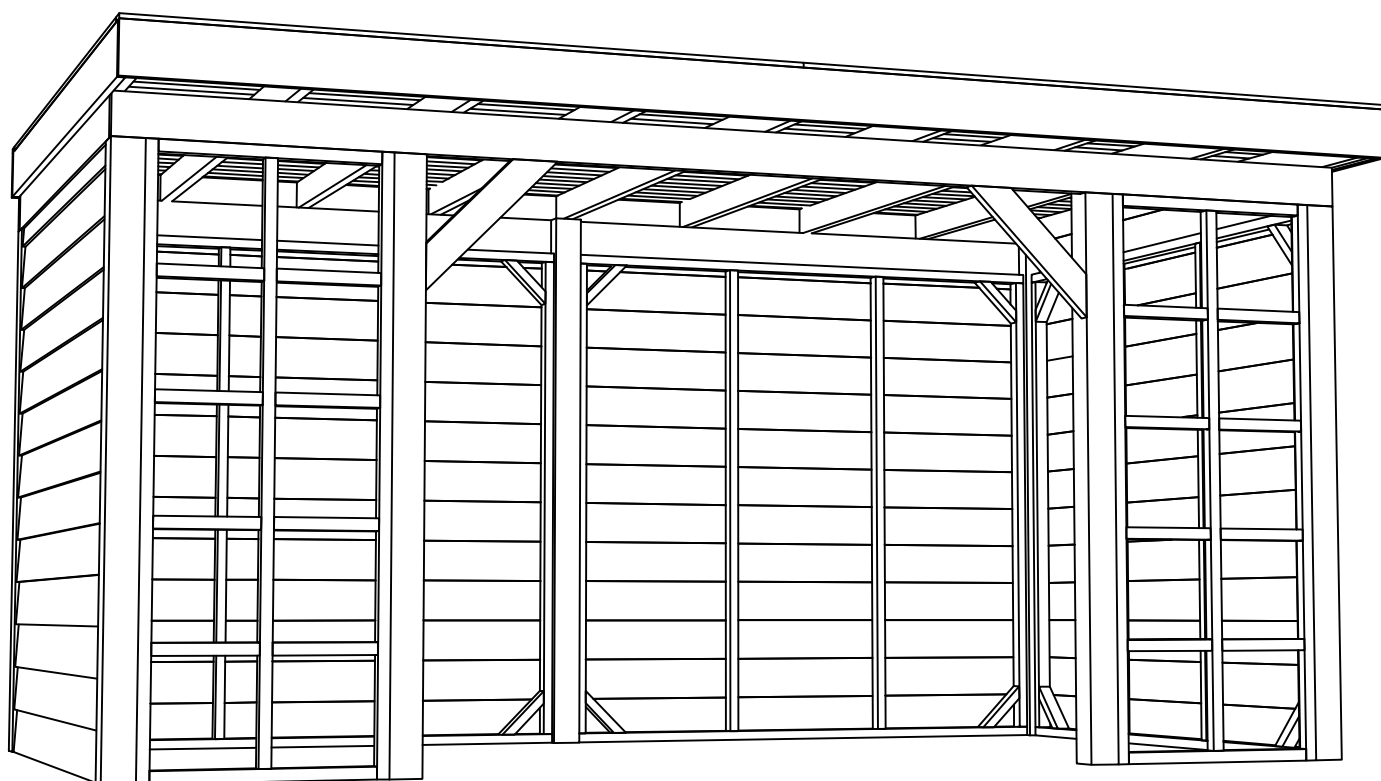

Buitenverblijf plat dak Comfort - 500x270	
Breedte tussen de palen	4690 mm
Diepte tussen de palen	2400 mm
Doorloophoogte	2240 mm

Basis onderdelen			
Aantal	Code	Lengte (mm)	Omschrijving
4	DBC P - 600	2400	Hoekpaal (120x120)
3	DBC P - 700	2400	Tussenpaal (120x120)
2	BVC-R1	2550	Ringbalk (45x160)
2	BVC-R2 - 500	4930	Ringbalk (45x160)
9	BVC-G1	2945	Gording (45x120)
2	DBC 27	700	Rechte schoor (45x120)
2	BVC-B1	2945	Boeiboord (28x195)
2	BVC-B2 - 500	4986	Boeiboord (28x195)
2	BVC-DL1	2861	Daklat (18x70)
4	BVC-DL2 - 500	2493	Daklat (18x70)
56	BVC-D1 - 500	2463	Dakhout (wb 108)

Wanden - Zwart geïmpregneerd			
Aantal	Code	Lengte (mm)	Omschrijving
2	W40935		Achterwand van enkelzijdig Zweeds rabat
4	1009297	4000	Frame (45x70)
10	1017075	2500	Frame (45x70)
26	1009204	4000	Zweeds rabatdeel (wb 180)
2	1011624		Zak bevestigingsmateriaal
2	W40945		Zijwand van enkelzijdig Zweeds rabat
14	1017075	2500	Frame (45x70)
14	1012885	5000	Zweeds rabatdeel (wb 180)
2	1011624		Zak bevestigingsmateriaal
2		890	Trellis
4	T-1	2240	Balk (45x45)
2	T-2	2240	Balk (45x45)
4	T-3	890	Balk (45x45)
8	T-4	890	Balk (45x45)
2			Zak bevestigingsmateriaal

Overige onderdelen			
Aantal	Code	Lengte (mm)	Omschrijving
2	1016903		Bevestigingsmateriaal
1		5300x3350	Set dakfolie met horizontale dakdoorvoer

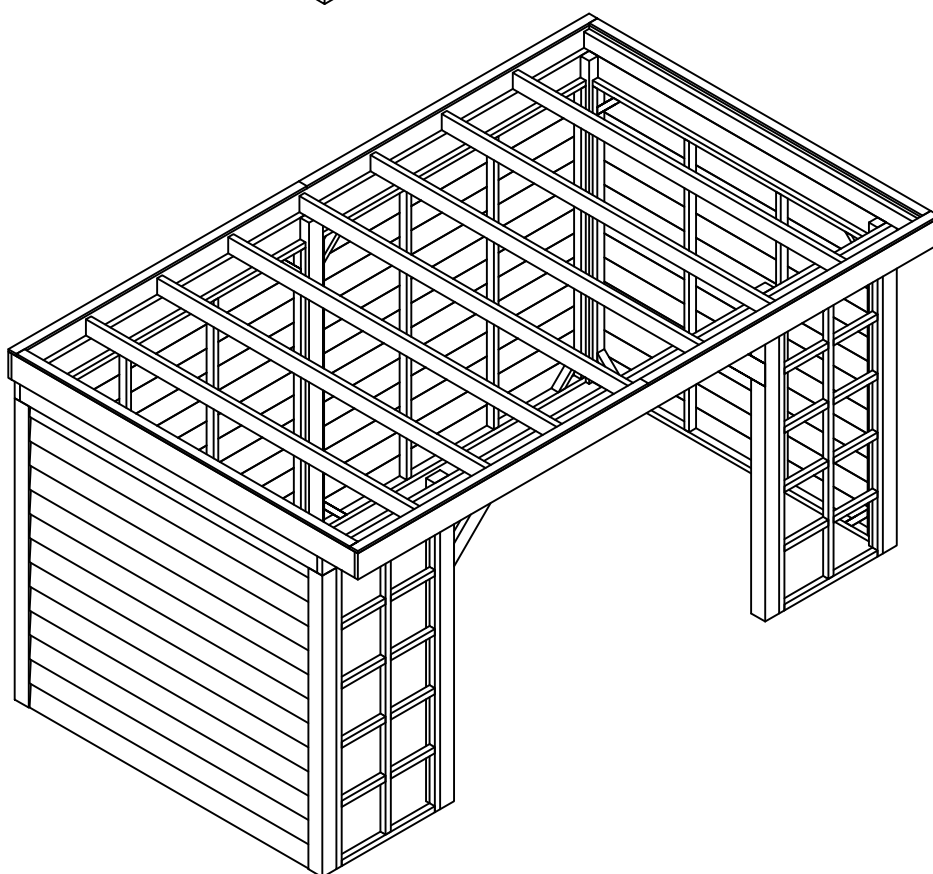
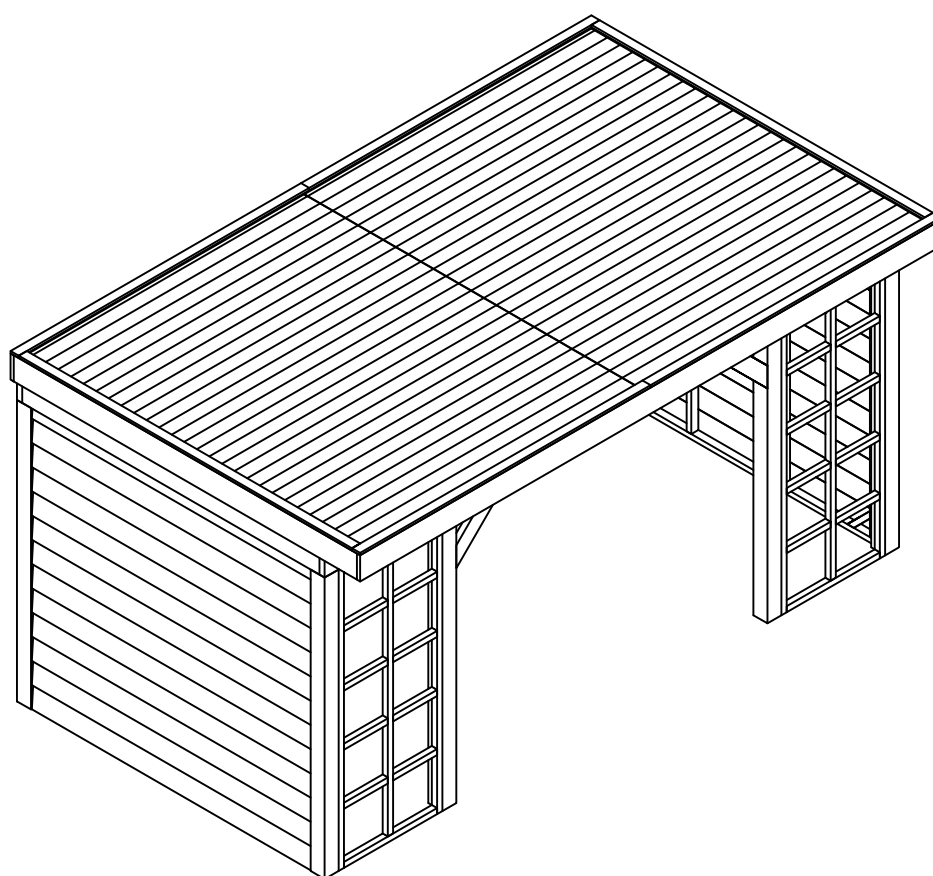

Palenplan

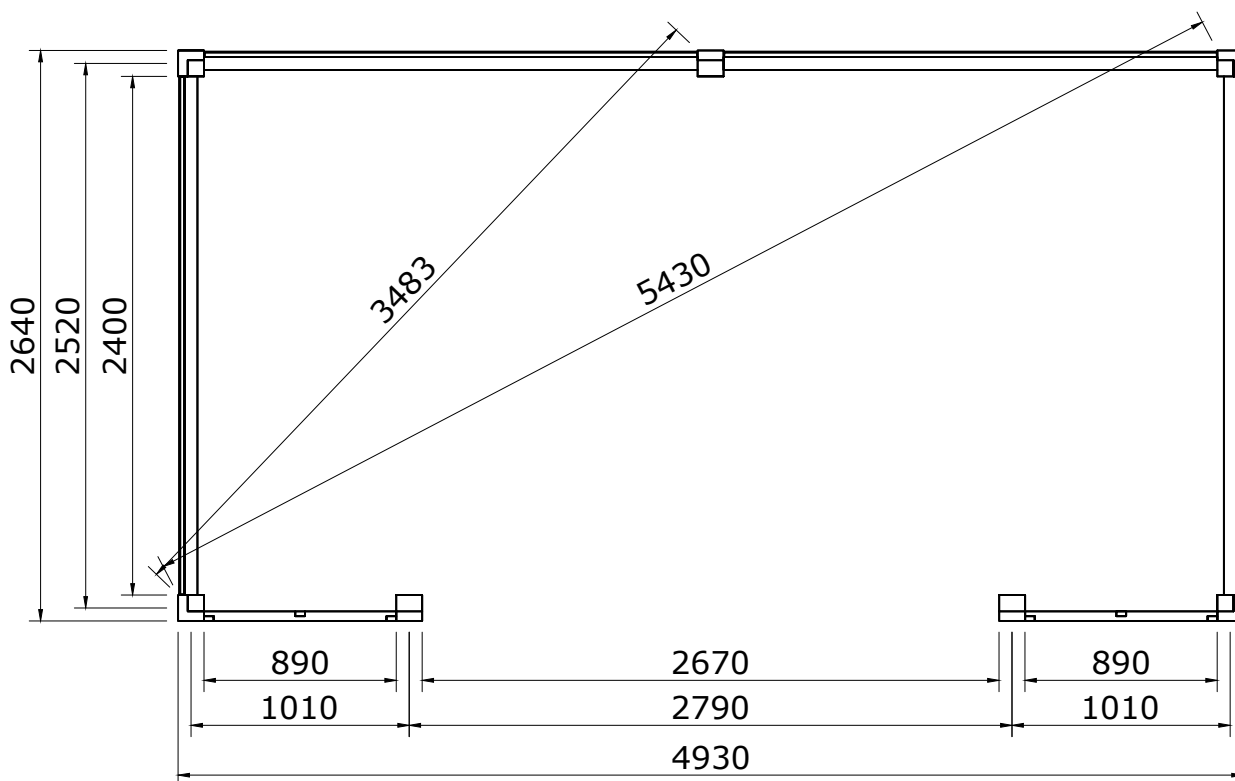

Voor aanzicht

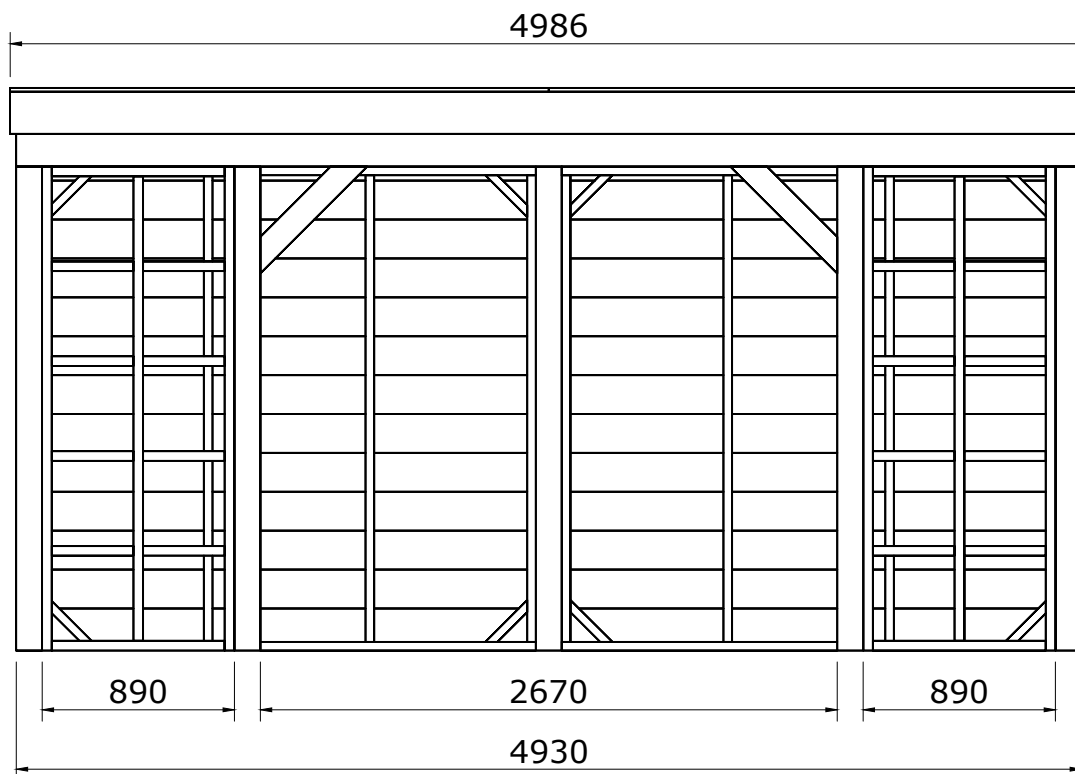

Rechter zijaanzicht

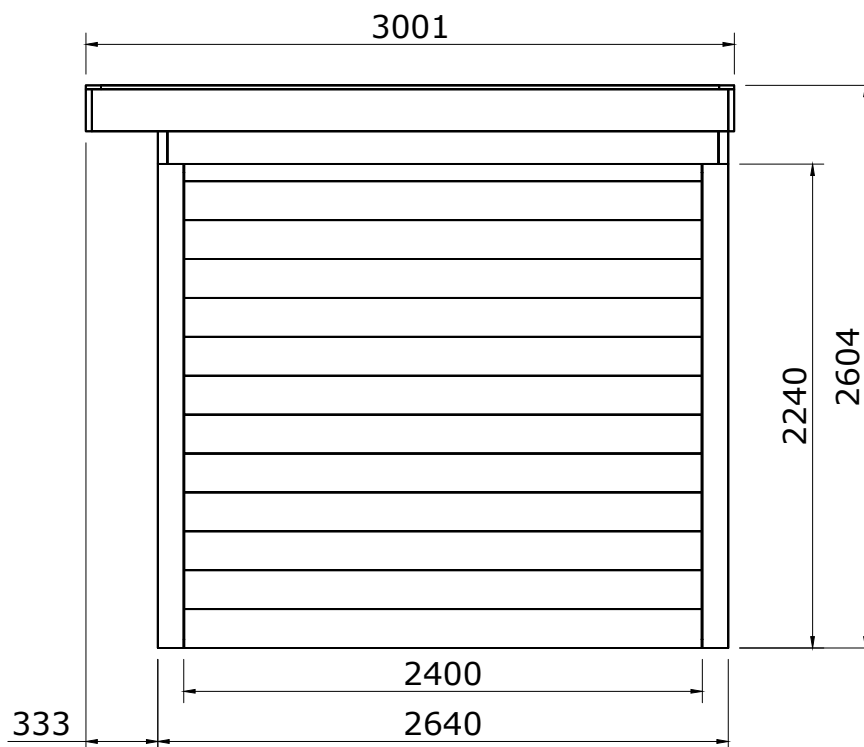

# 4

## Montagetekeningen

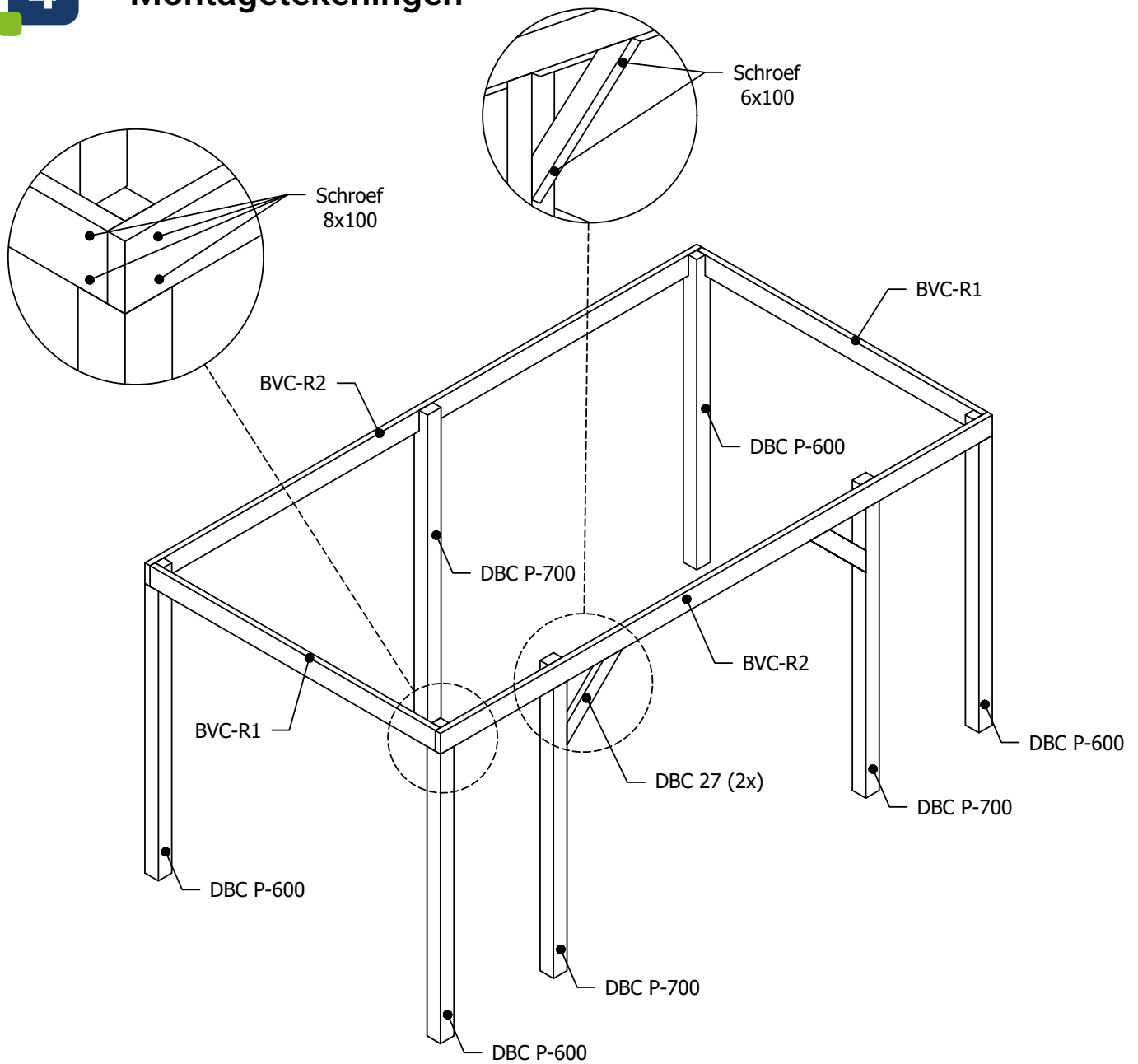

Bovenaanzicht

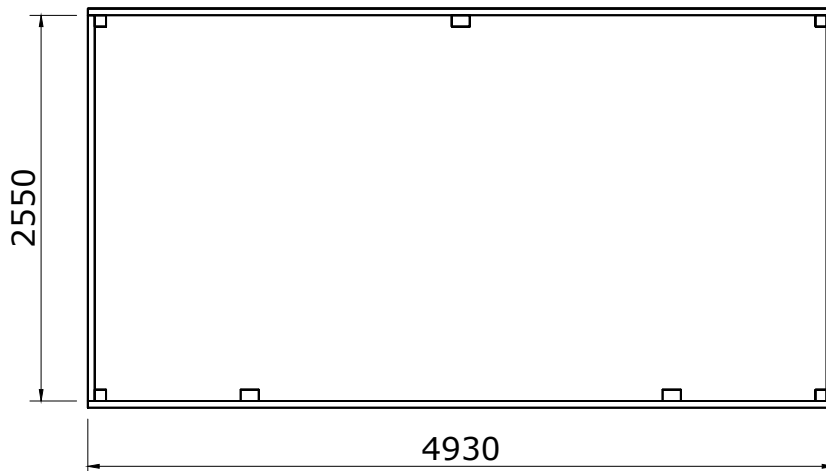

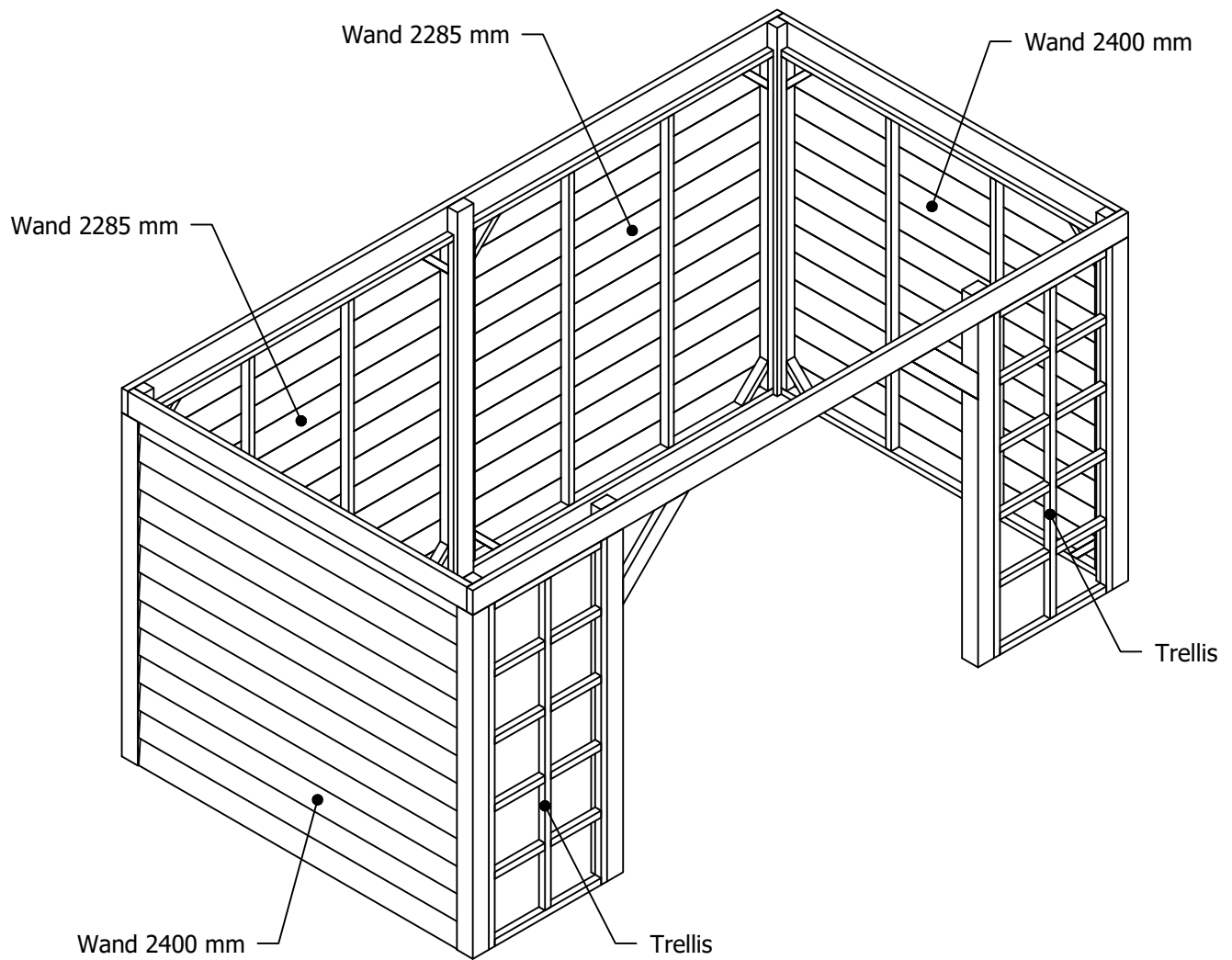

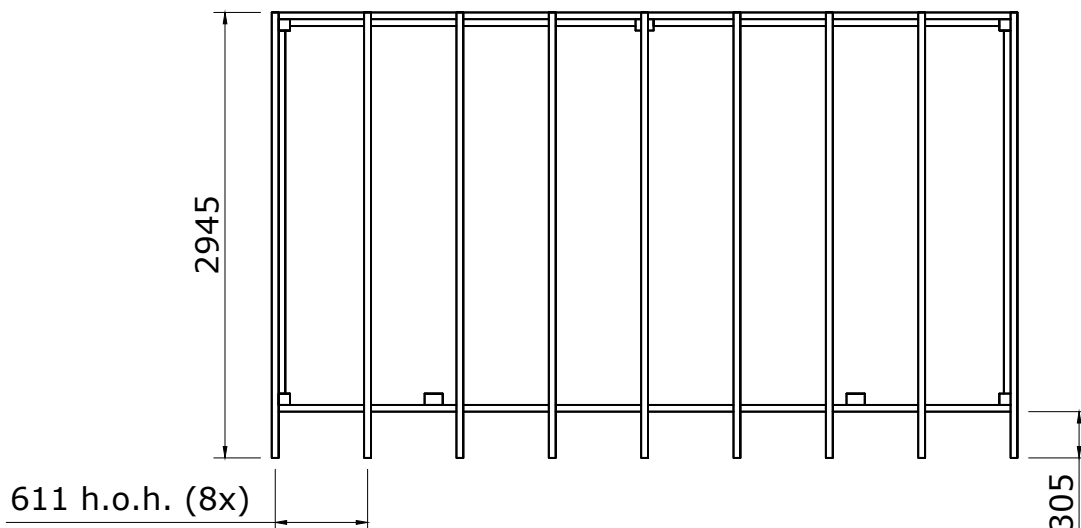
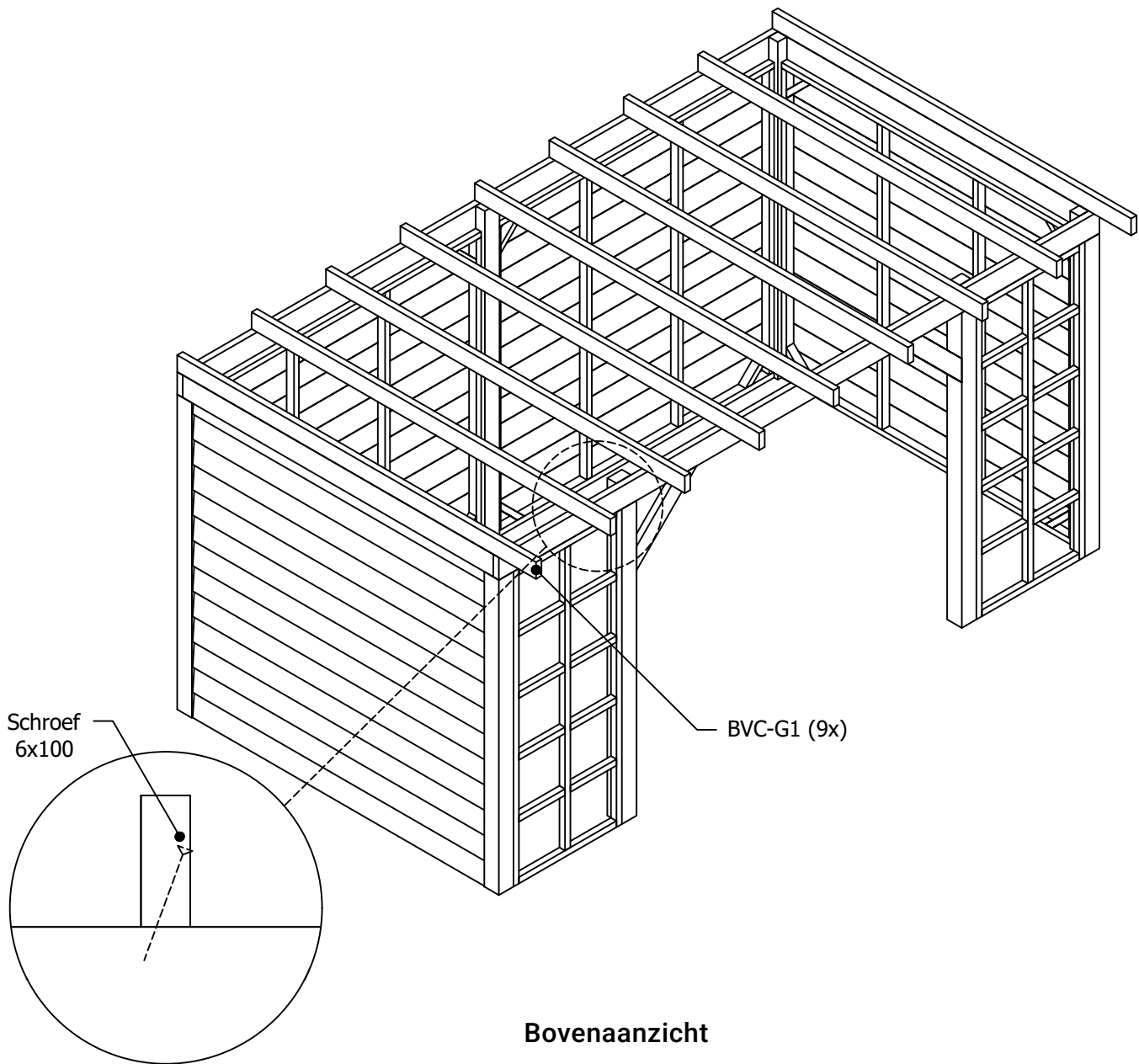



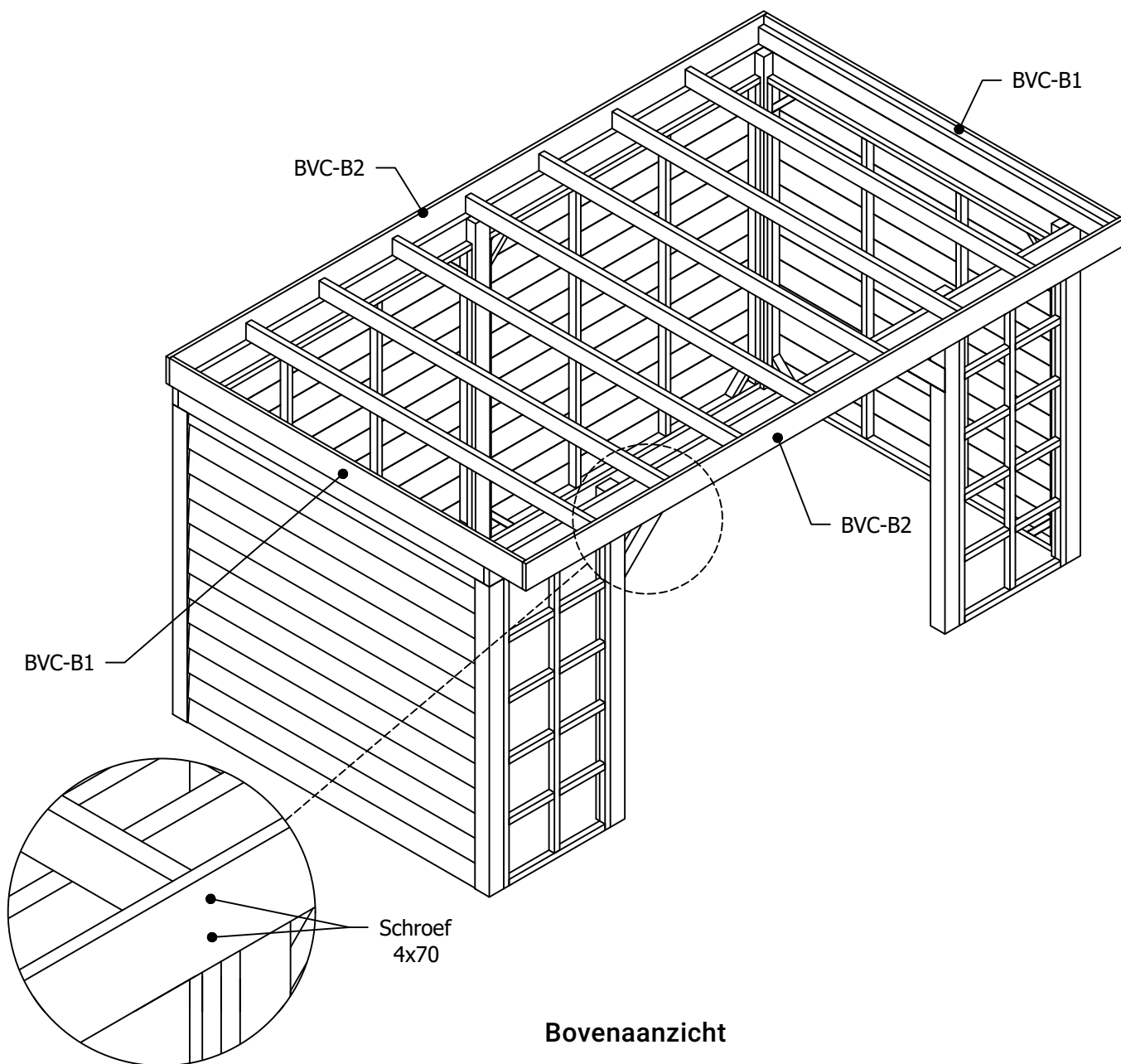

Bovenaanzicht

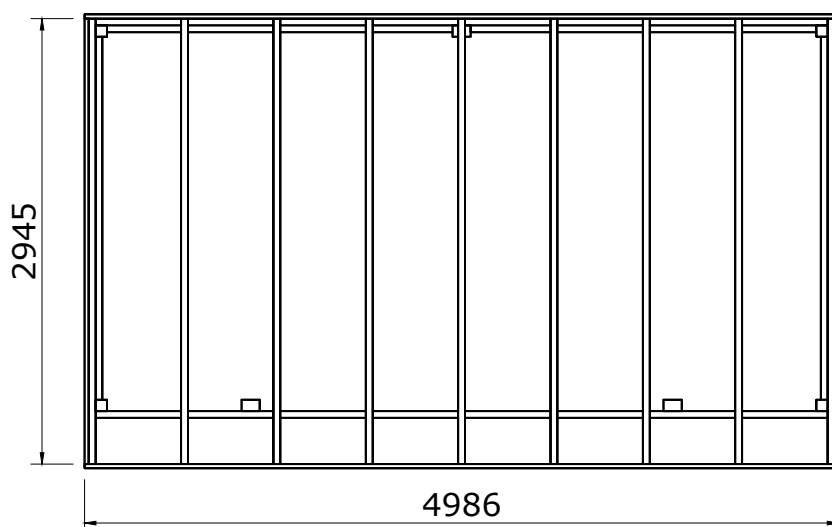

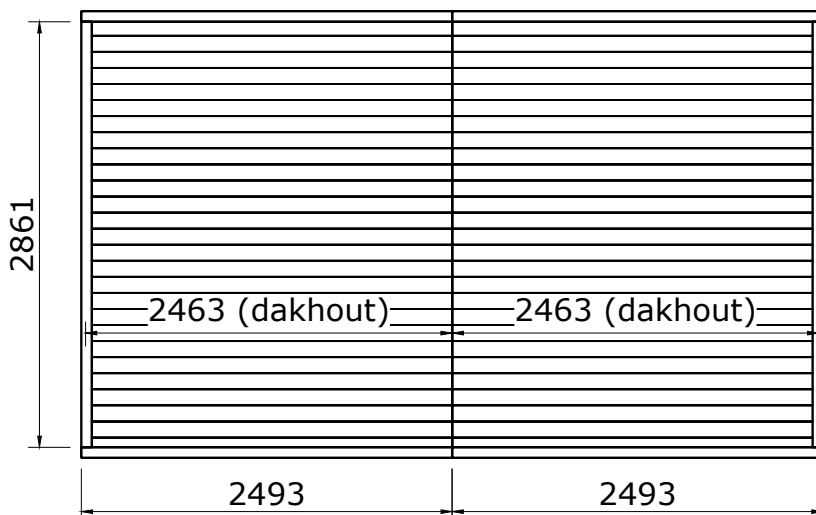
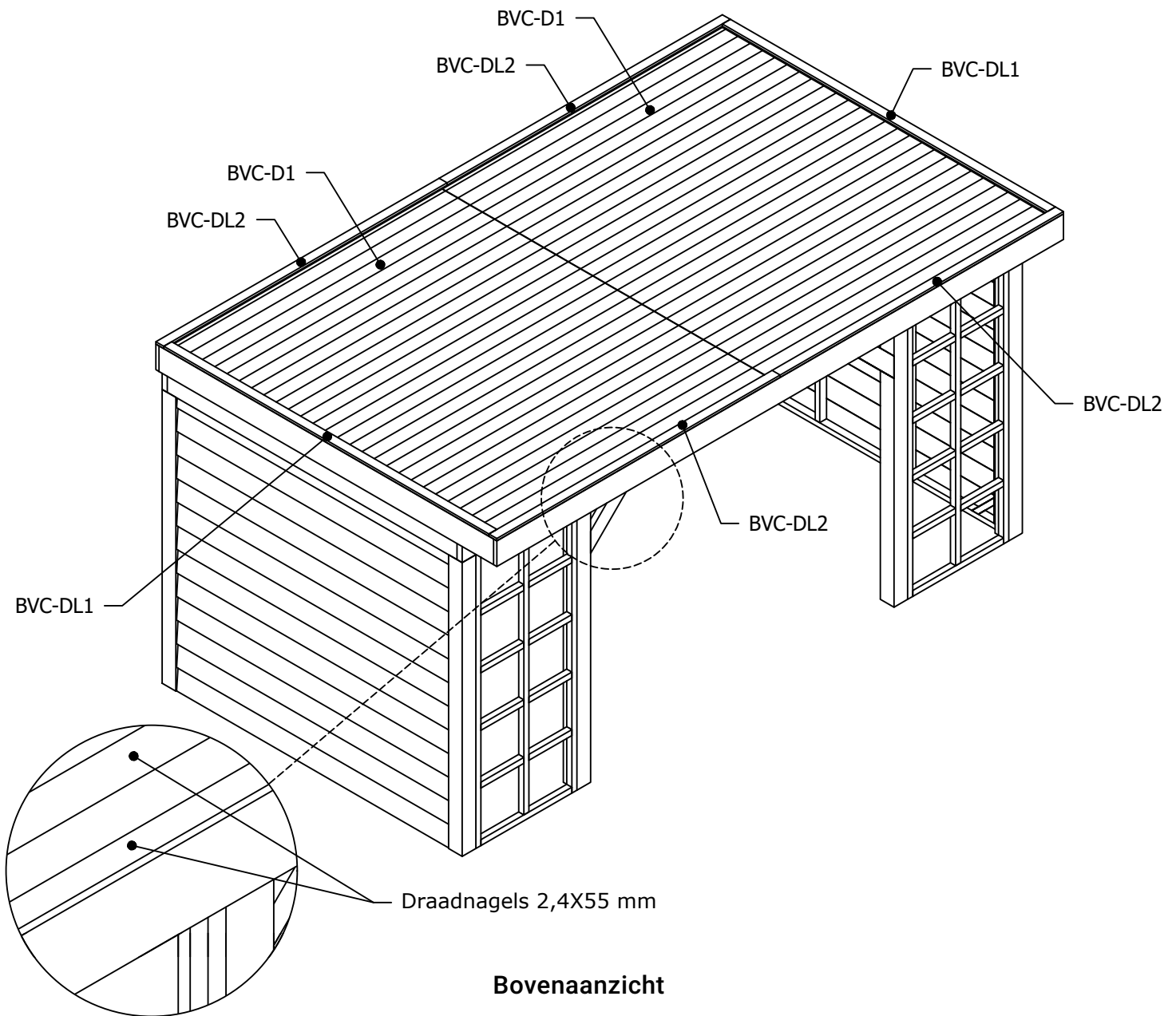



# Montagetekeningen

Zijwand van enkelzijdig Zweeds rabat (2400 mm)  
(De onderdelen dienen zelf op maat gemaakt te worden)

