



All sizes are approximate and in cm

| | |
|---|--|
|  7,8+3,6m² |  - |
|  28,6m³ |  44mm |
|  19,4m² |  4-6-4mm |

| |
|---|
|  998kg |
|  440x120x73cm |

**cabin:
Agnes**

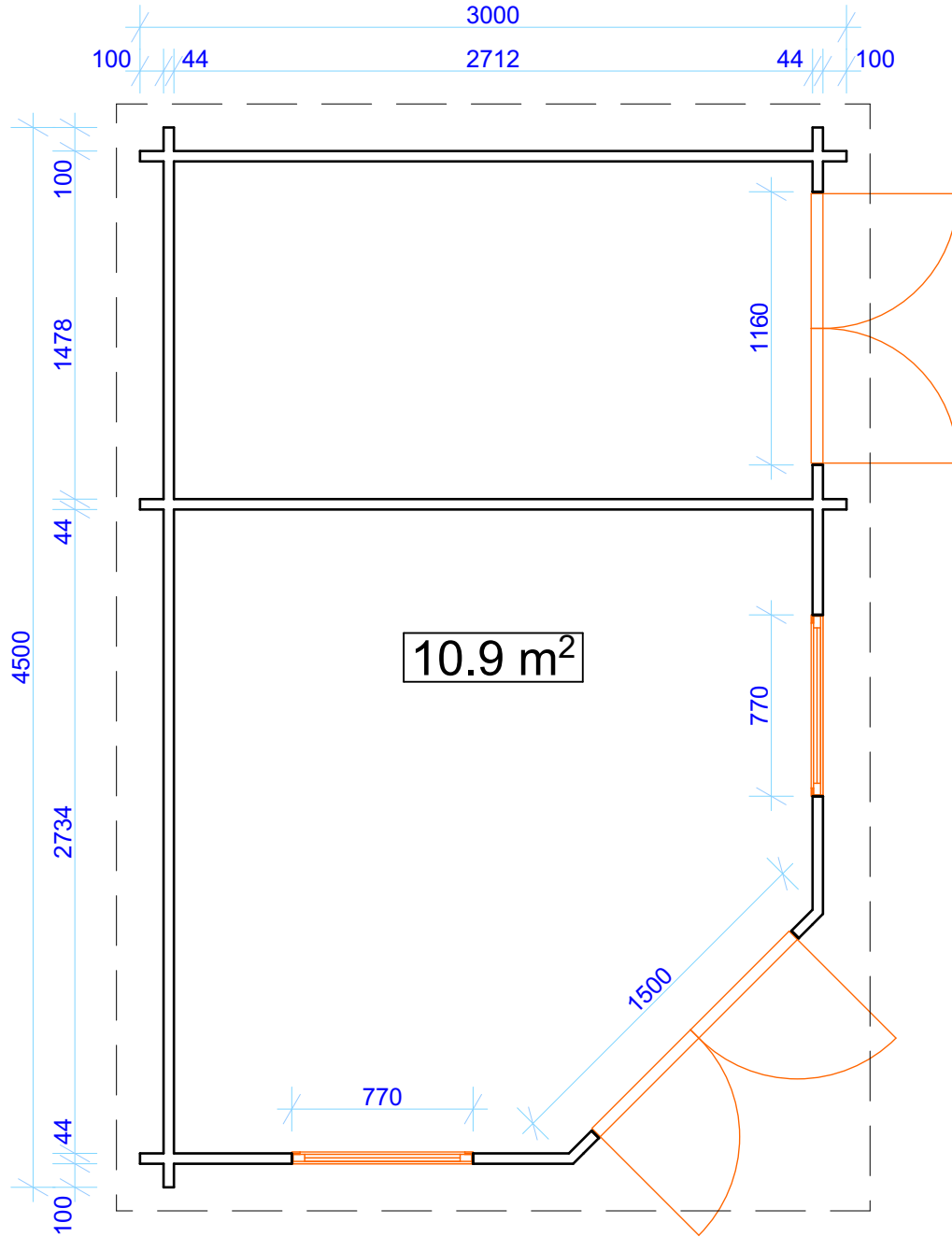

Size (m) 3,00 x 3,00
 Lower Wall Height 2180 mm
 Ridge Height 2980 mm
 Wall log 44 mm

| | id | size (h x w) | Pcs |
|---------|------------------|----------------|-----|
| Doors | DGD-2 | 1920 x 1200 mm | 1 |
| | D-2 (SOLID DOOR) | 1880 x 1200 mm | 1 |
| Windows | DGW-2C | 1120 x 770 mm | 2 |

Always keep the package number saved! Without package number there is no guarantee.
 Package number:

WALL LOG (mm): 45

BUILDING CODE

Agnes

SIZE (mm): 4400x3000

COMPONENT SPECIFICATION

| NUMBER | COMPONENT FUNCTION | COMPONENT CODE | VIEW | SIDE VIEW | DIMENSIONS (mm) | | | QUANTITY (psc.) |
|--------|--------------------|----------------|------|-----------|-----------------|---------|-----------|-----------------|
| | | | | | LENGHT | WIDTH | THICKNESS | |
| 1 | Wall board | A1 | | | 3434 | 115 | 45 | 1 |
| 2 | Wall board | A2 | | | 2014 | 115 | 45 | 5 |
| 3 | Wall board | A3 | | | 617 | 115 | 45 | 10 |
| 4 | Wall board | A4 | | | 617 | 115 | 45 | 10 |
| 5 | Wall board | A5 | | | 2980 | 115 | 45 | 1 |
| 6 | Wall board | A6 | | | 200 | 115 | 45 | 16 |
| 7 | Wall board | B1,A7 | | | 4400 | 115 | 45 | 19 |
| 8 | Wall board | B2,A8 | | | 4400 | 115 | 45 | 2 |
| 9 | Wall board | D2,E2,C5 | | | 3000 | 115 | 45 | 38 |
| 10 | Wall board | C6,E3 | | | 3000 | 115 | 45 | 2 |
| 11 | Wall board | C2 | | | 2034 | 115 | 45 | 6 |
| 12 | Wall board | C3 | | | 627 | 115 | 45 | 10 |
| 13 | Wall board | C4 | | | 627 | 115 | 45 | 10 |
| 14 | Wall board | | | | | | | |
| 15 | Wall board | | | | | | | |
| 16 | Wall board | | | | | | | |
| 17 | Wall board | | | | | | | |
| 18 | Wall board | | | | | | | |
| 19 | Wall board | | | | | | | |
| 20 | Wall board | | | | | | | |
| 21 | Wall board | | | | | | | |
| 22 | Wall board | | | | | | | |
| 23 | Wall board | | | | 2034 | 60 | 45 | 1 |
| 24 | Wall board | C1 | | | 3000 | 60 | 45 | 2 |
| 25 | Wall board | D1,E1 | | | | | | |
| 26 | Wall board | D3 | | | 3000 | 115 | 45 | 1 |
| 27 | Window | | | | 770 | 1120 | | 2 |
| 28 | Door | | | | 1200 | 1880 | | 1 |
| 29 | Door | | | | 1200 | 1880 | | 1 |
| 30 | Roof cover fixture | | | | 3300 | 100/120 | 16 | 2 |
| 31 | Roof cover fixture | | | | 2350 | 100/120 | 16 | 4 |
| 32 | Roof board | | | | 1430 | 110 | 19 | 8 |
| 33 | Beam | | | | 2283 | 60 | 40 | 4 |
| 34 | Beam | | | | 1693 | 60 | 40 | 4 |
| 35 | Beam | | | | 1734 | 60 | 40 | 2 |
| 36 | Beam | | | | 1682 | 60 | 40 | 2 |
| 37 | Beam | | | | 990 | 60 | 40 | 8 |
| 38 | Beam | | | | 1400 | 120 | 40 | 1 |
| 39 | Trigonal | | | | | | | 1 |

PACKAGE NR.:

MNFCT. ORDER NR.:

CONTROL 1

CONTROL 2

PAGE/PAGES:

1/7

SIGNATURE

SIGNATURE

BUILDING CODE **Agnes**

WALL LOG (mm): 45

SIZE (mm): 4400x3000

ISOMETRIC VIEW

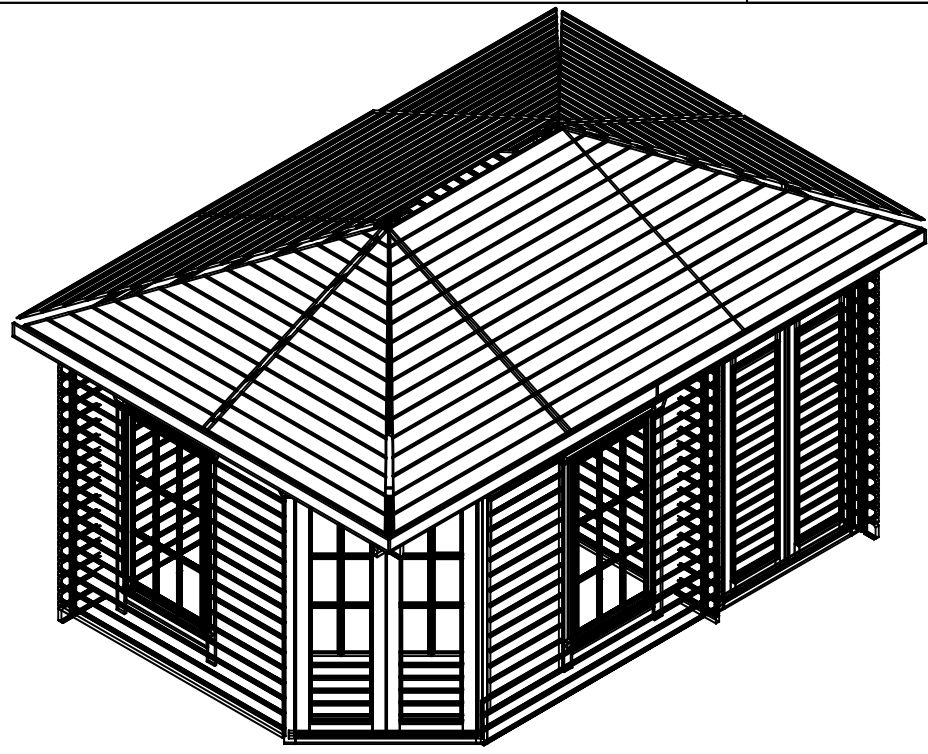

TOP VIEW

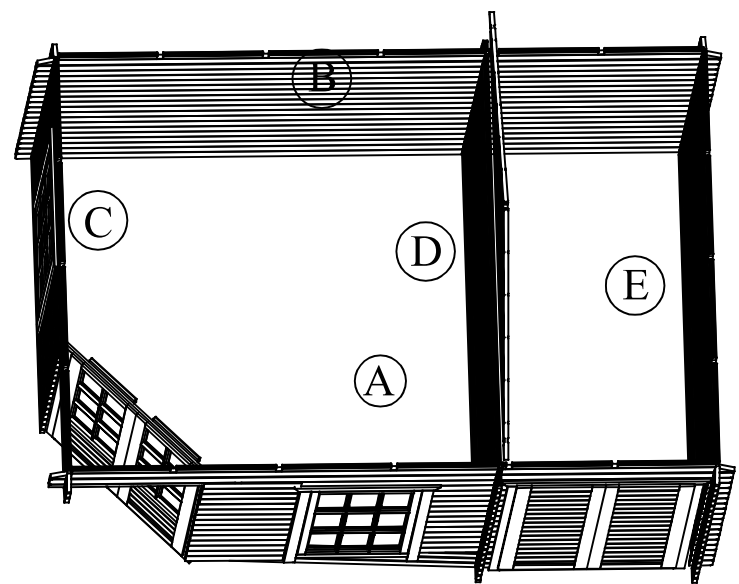

PACKAGE NR.:

MNFCT. ORDER NR.:

CONTROL 1
SIGNATURE

CONTROL 2
SIGNATURE

PAGE/PAGES: **2/7**

BUILDING CODE **Agnes**

WALL LOG (mm): 45

SIZE (mm): 4400x3000

FRONT VIEW

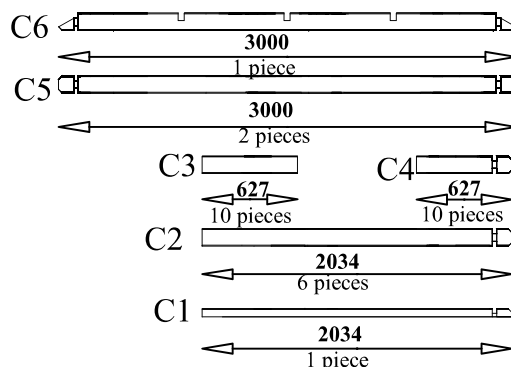
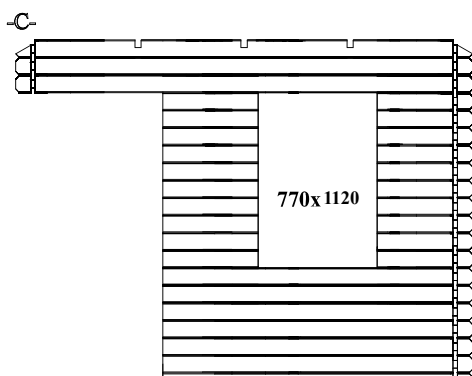

INSIDE VIEW

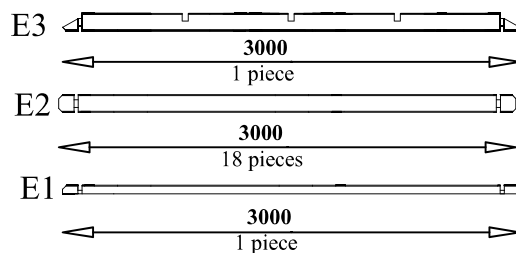
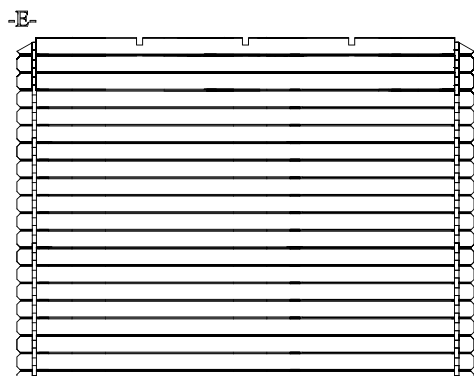

BACK VIEW

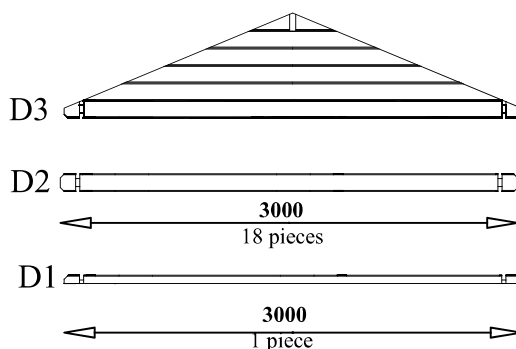
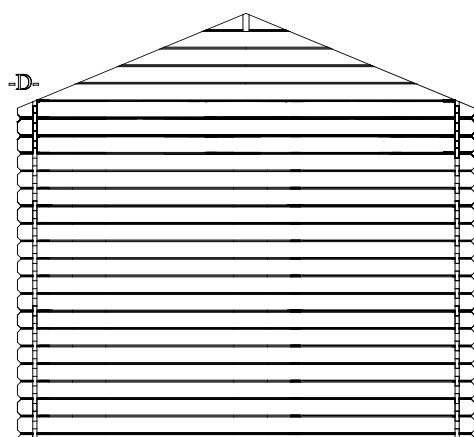

PACKAGE NR.:

MNFCT. ORDER NR.:

CONTROL 1
SIGNATURE

CONTROL 2
SIGNATURE

PAGE/PAGES: **3/7**

BUILDING CODE **Agnes**

WALL LOG (mm): 45

SIZE (mm): 4400x3000

LEFT VIEW

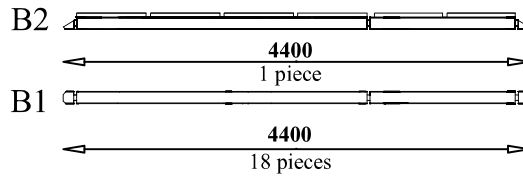
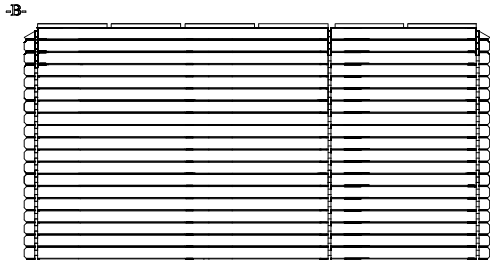

RIGHT VIEW

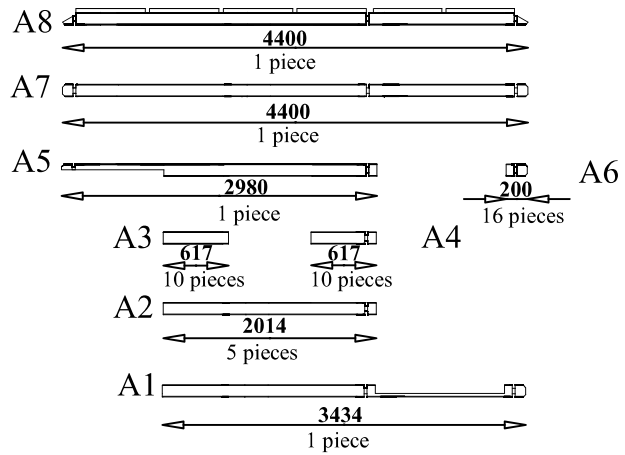
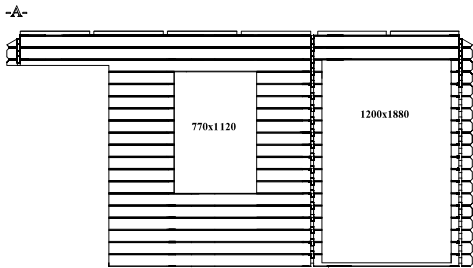

PACKAGE NR.:

MNFCT. ORDER NR.:

CONTROL 1
SIGNATURE

CONTROL 2
SIGNATURE

PAGE/PAGES: **4/7**

BUILDING CODE **Agnes**

WALL LOG (mm): 45

SIZE (mm): 4400x3000

CONSTRUCCION 1

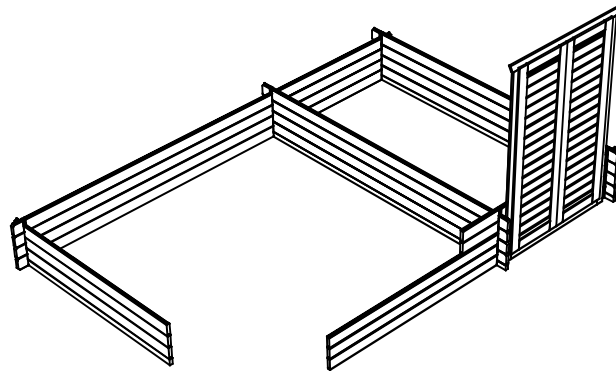

CONSTRUCCION 2

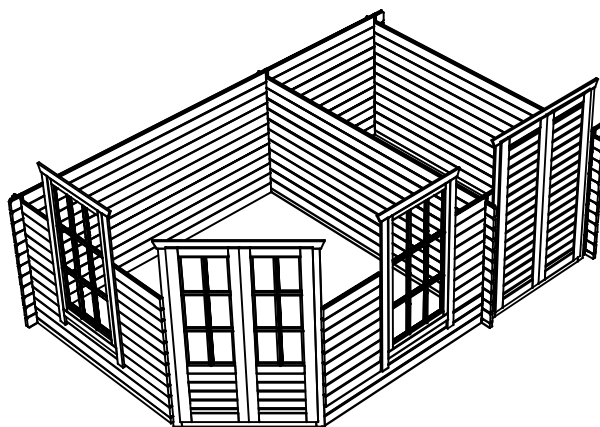

PACKAGE NR.:

MNFCT. ORDER NR.:

CONTROL 1

SIGNATURE

CONTROL 2

SIGNATURE

PAGE/PAGES: **5/7**

BUILDING CODE

Agnes

WALL LOG (mm): 45

SIZE (mm): 4400x3000

CONSTRUCCION 3

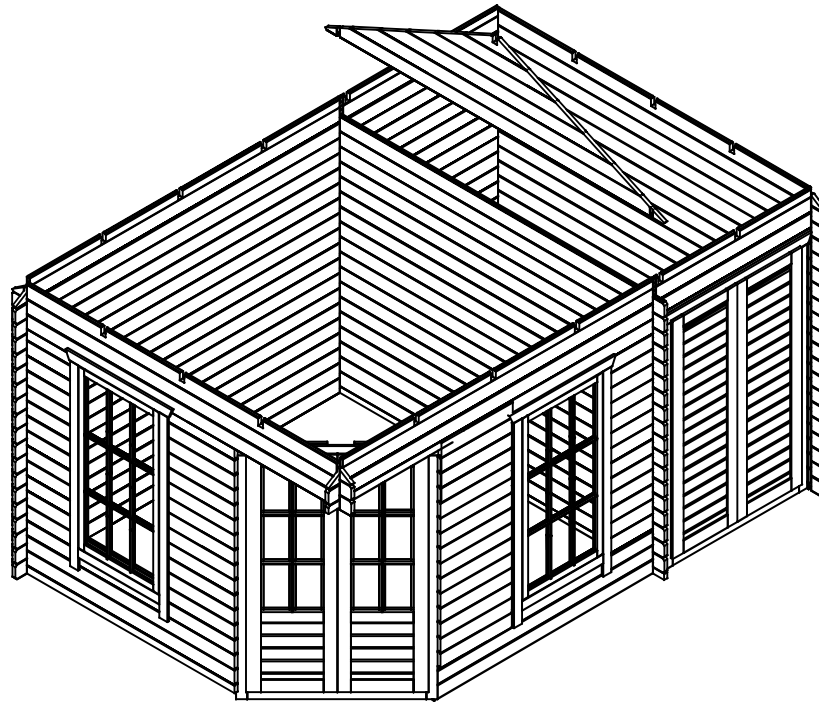

CONSTRUCCION 4

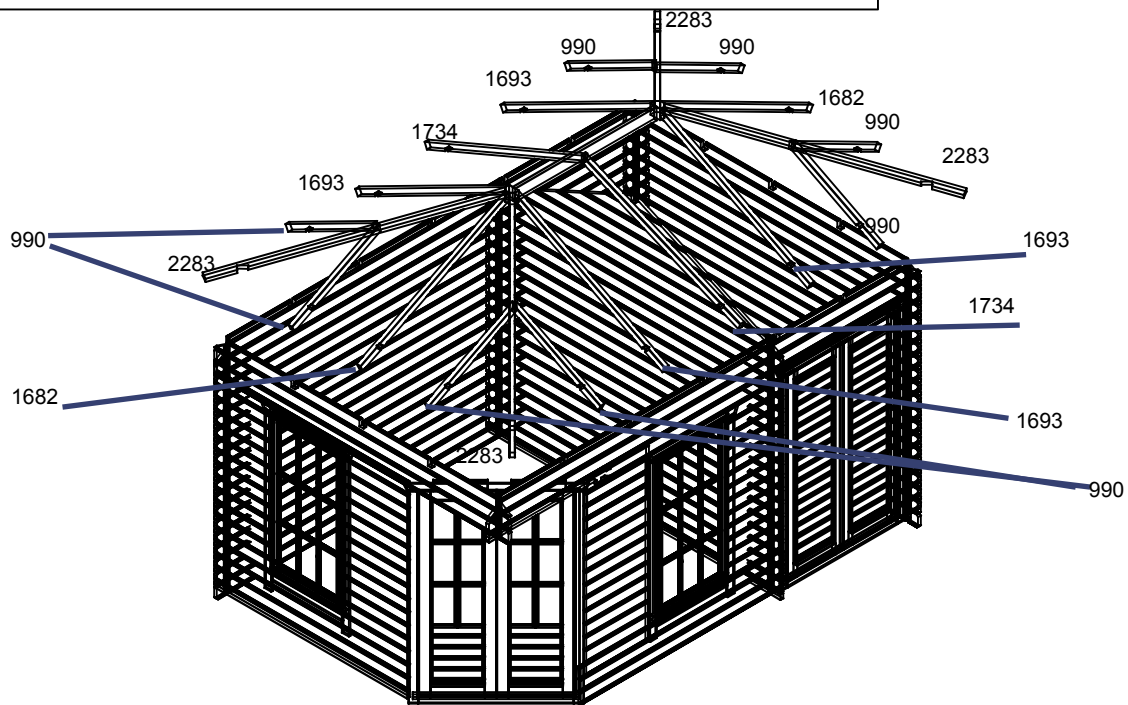

PACKAGE NR.:

MNFCT. ORDER NR.:

CONTROL 1

CONTROL 2

SIGNATURE

SIGNATURE

PAGE/PAGES: **6/7**

BUILDING CODE **Agnes**

WALL LOG (mm): 45

SIZE (mm): 4400x3000

ISOMETRIC ROOF'S CONSTRUCTION

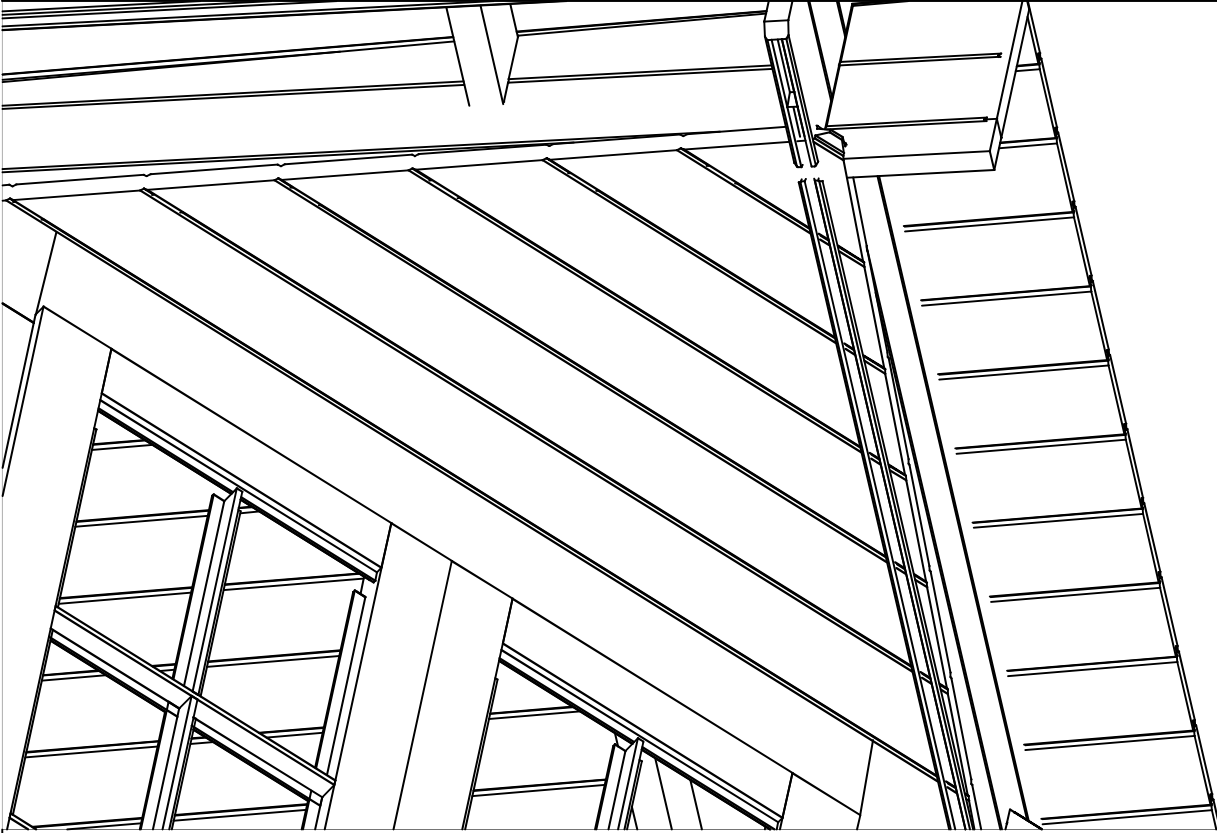

PACKAGE NR.:

MNFCT. ORDER NR.:

CONTROL 1

CONTROL 2

SIGNATURE

SIGNATURE

PAGE/PAGES: **7/7**

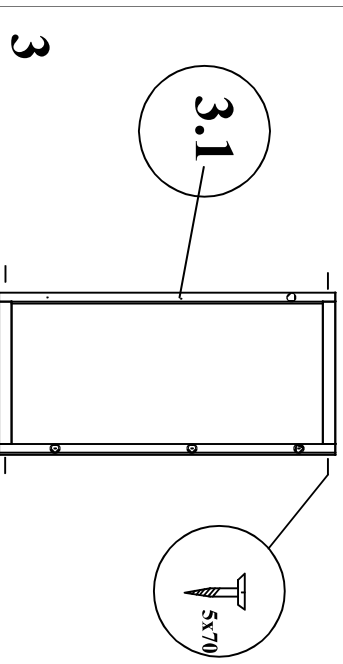
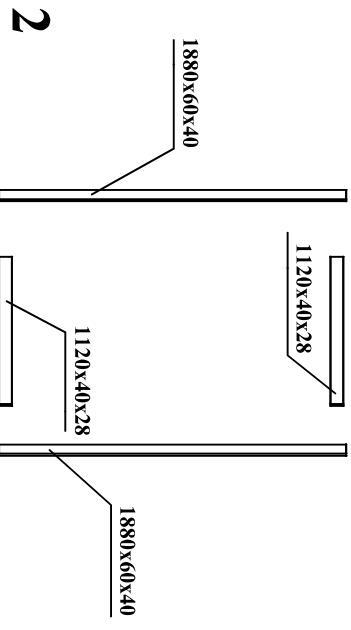
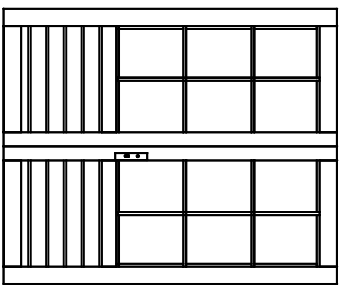

3.1

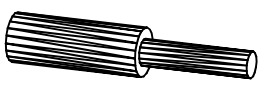

4

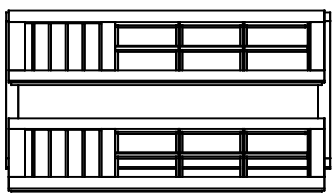

5

