

TUINDECO

LEADING IN GARDEN PRODUCTS

40.0723

Asmund

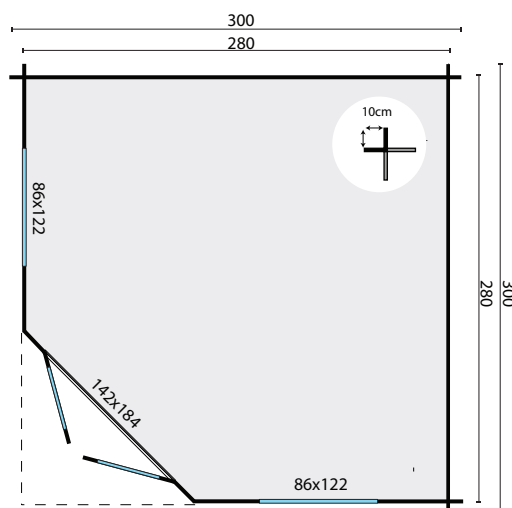

All sizes are approximate and in cm

 7,0m²

 17,9m³

 11,0m²

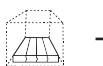

-

 28mm

 4mm



650kg



333x114x60cm

**cabin:
Asmund**

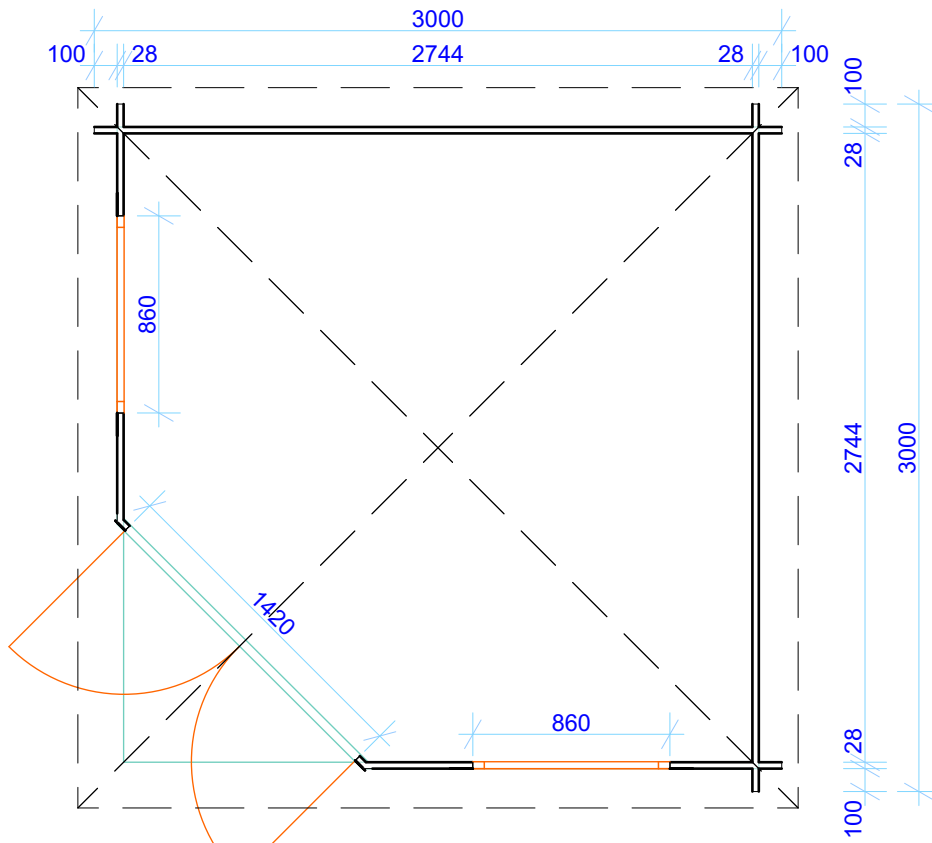





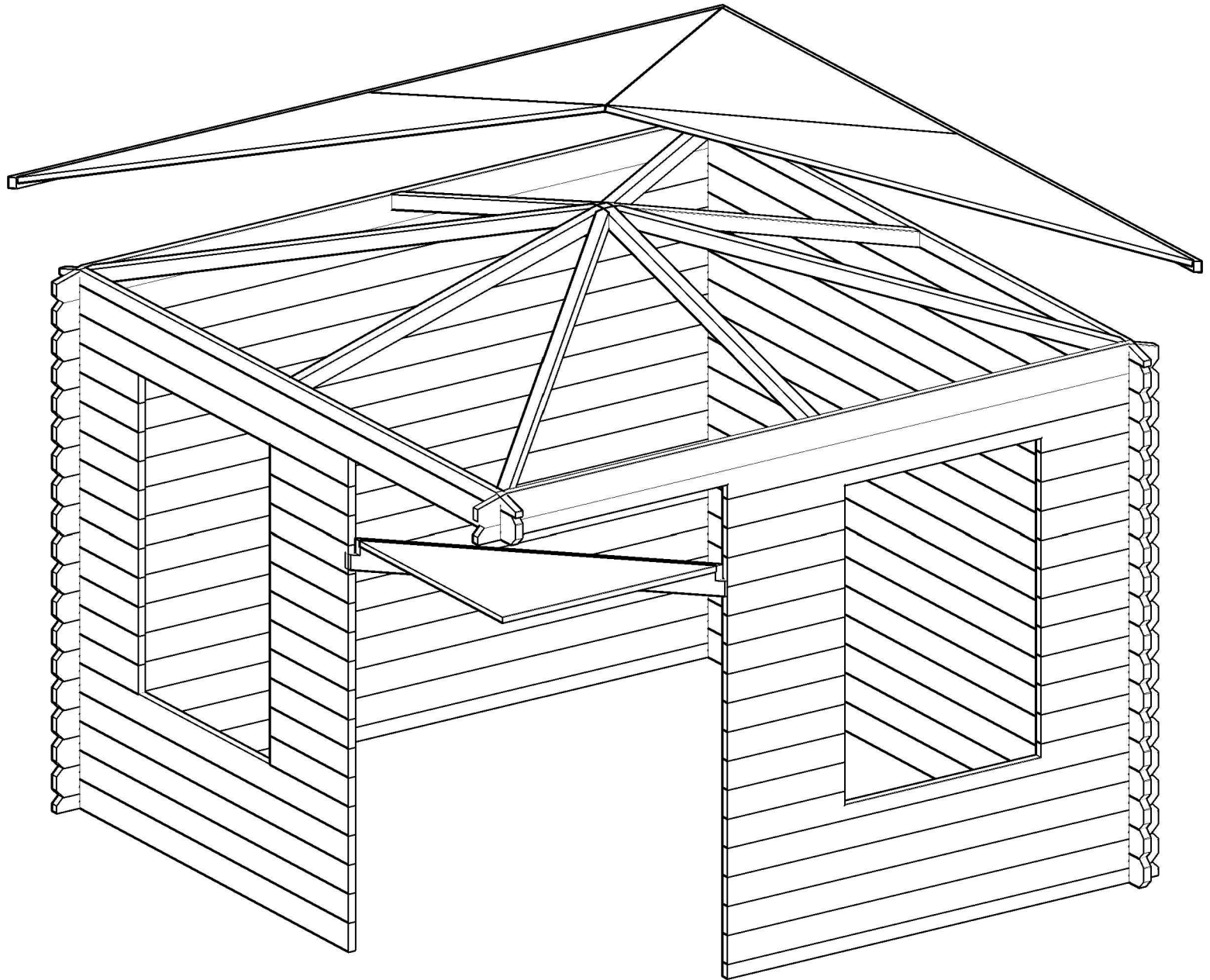



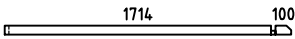
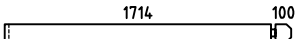
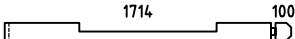

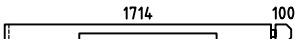
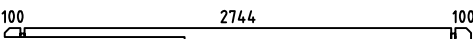
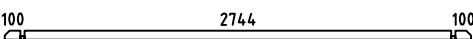
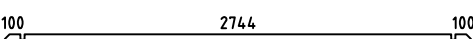
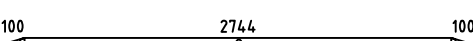
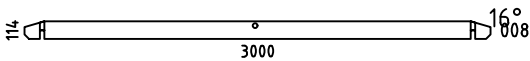
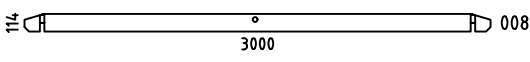
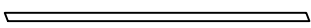
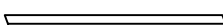



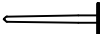

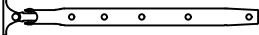

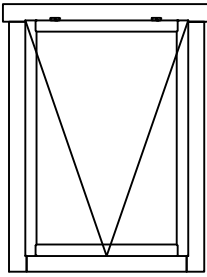
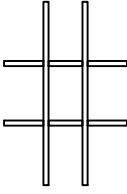
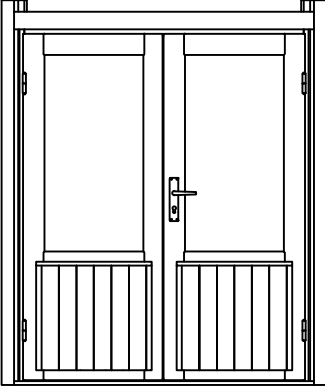
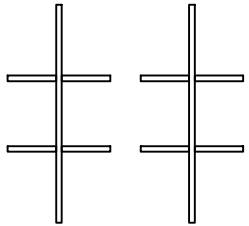
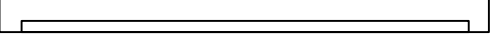

Size (m) 3,00 x 3,00
 Lower Wall Height 2110 mm
 Ridge Height 2500 mm
 Wall log 28 mm

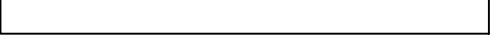
| | id | size (h x w) | Pcs |
|---------|--------|---------------|-----|
| Doors | DGD-2 | 1840x 1420 mm | 1 |
| Windows | DGW-1A | 1220 x 860 mm | 2 |

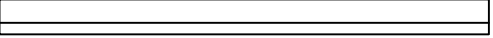

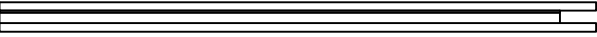
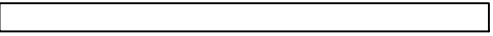
Asmund28-250

| Pos | Specification-Spezifikation-Specificatie | St. | Profile (mm) | Length (mm) |
|------|--|------|------------------|-------------|
| 001 |  | 1 | 28x57 | 1842 |
| 002 |  | 10 | 28x114 | 1842 |
| 003 |  | 1 | 28x114 | 1842 |
| 004 |  | 21 | 28x114 | 480 |
| 005 |  | 21 | 28x114 | 480 |
| 006 |  | 1 | 28x114 | 1842 |
| 007 |  | 1 | 28x114 | 3000 |
| 009 |  | 1 | 28x57 | 3000 |
| 010 |  | 36 | 28x114 | 3000 |
| 011 |  | 2 | 28x57 | 3000 |
| W1-1 |  | 1 | | |
| W2-1 |  | 1 | | |
| SR2 | RAFTER-DACHSPARREN-DAKSPAR  | 4 | 44x55 | 1960 |
| SR1 | RAFTER-DACHSPARREN-DAKSPAR  | 4 | 44x55 | 1420 |
| L-1 | Eave Slat-Traufenleiste-Afdekljst  | 4 | 40x18 | 3250 |
| DE1 | Roof Panel-Dach Elemente-Dakpanelen  | 4+4 | 1620x1560 | |
| PE1 | Ceiling Element-Deckenelement-Plafond Element 1  | 1 | 931x1316 | |
| | Double Door Set-Doppeltür Satz-Dubbele Deur Set  3x25 x2 4x60 x4 | 1 | | |
| | Nail-Nagel-Spijker 1.2x20  | 30 | 1.2x20 | |
| N1 | Ridge piece-Firstelement-Nokstuk  | 1 | | |
| | Screw-Schraube-Schroef 4x60  | 70 | | |
| WS1 | Window Stay-Fensterfeststelle  | 2 | | |
| HS1 | Wood Bolt set-Holzschraubesatz-Hout Bout 8x80  | 4 | | |
| | | | | |
| | | | | |
| Kood | Materjal | File | Asmund28-250.dwg | Leht 1/2 |

| Pos | Specification-Spezifikation-Specificatie | | | St. | Profile (mm) | Length (mm) |
|-----------------------|---|--|---|------|------------------|-------------|
| W9N 86.5 x122.5 | <p>WINDOW 865x1225</p>  <p>Window Glazing Bar Fenstersprossen Raamroeden</p>  | | | 2 | | |
| DD6P 141 5x184 | <p>DOOR 1415x1840</p>  <p>Door Glazing Bar Türsprossen Deuroeiden</p>  | | | 1 | | |
| CORNER DOOR SET | | | | | | |
| 1 | Top Jamb |  |  | 1 | 58x42 | 1415 |
| 2 | Threshold |  |  | 1 | 58x42 | 1415 |
| 3-4 | Vertical Jamb |  |  | 2 | 58x42 | 1840 |
| 5-6 | Post Set |  | | 1+1 | 42x61 | 1970 |
| 7-8 | Cover Slat |  |  | 2 | 40x18 | 1810 |
| 9-10 | Casting | |  | 2 | 18x95 | 1500 |
| | Screw-Schraube-Schroef 4x60 | |  | 16 | | |
| | Screw-Schraube-Schroef 5x90 | |  | 16 | | |
| | | | | | | |
| | | | | | | |
| | | | | | | |
| | | | | | | |
| | | | | | | |
| | | | | | | |
| | | | | | | |
| Kood | Materjal | | | File | Asmund28-250.dwg | Leht 2/2 |

H = 1.500 m
 TOTAL: 7.05 m²

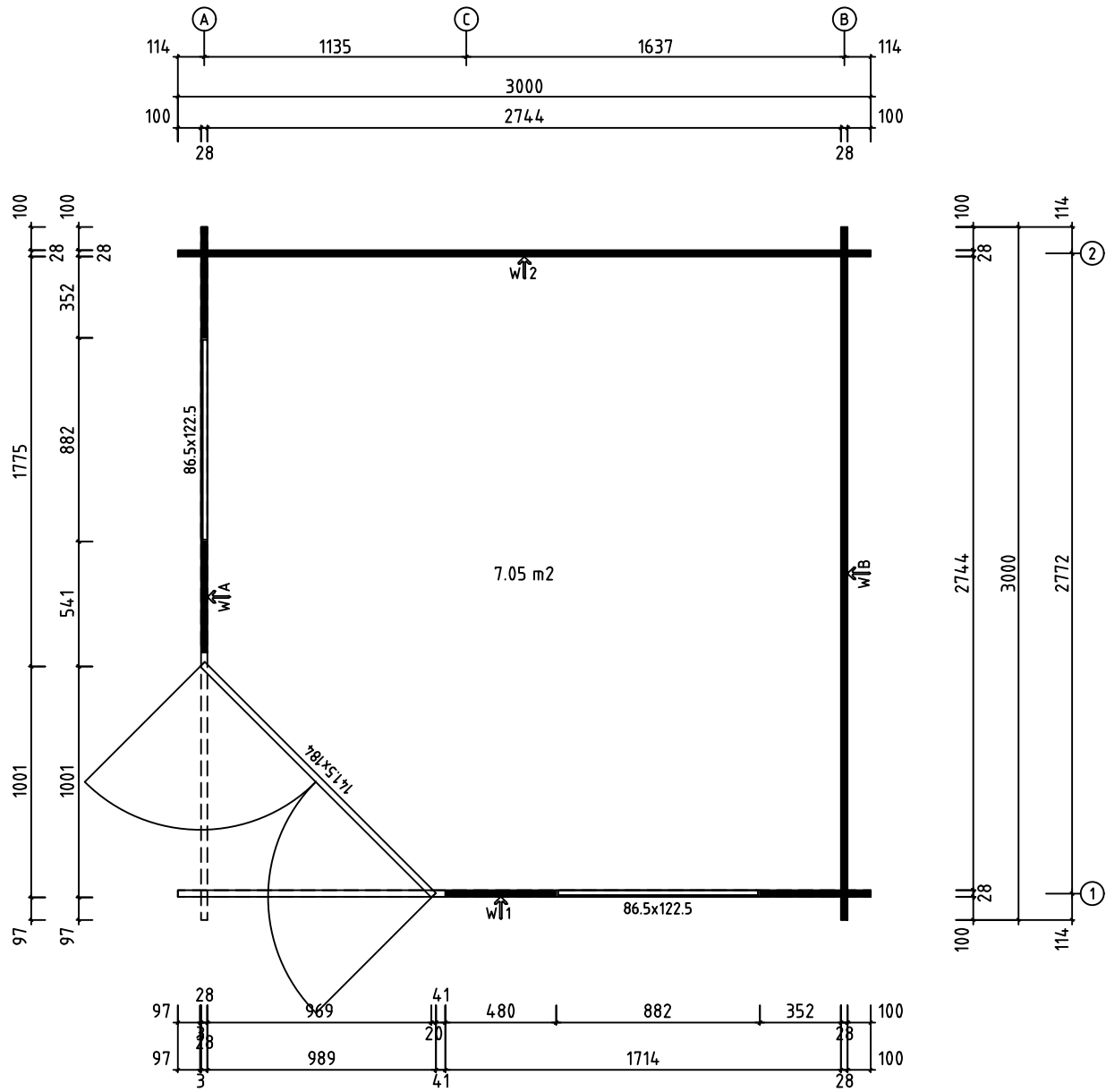

| | | | |
|----------|--------------|-------|------------------|
| Model | Asmund28-250 | Page | PLAN |
| Client | | Scale | 1:20 |
| Material | 28x114 | Date | 06.11.2018 |
| Company | | File | Asmund28-250.dwg |

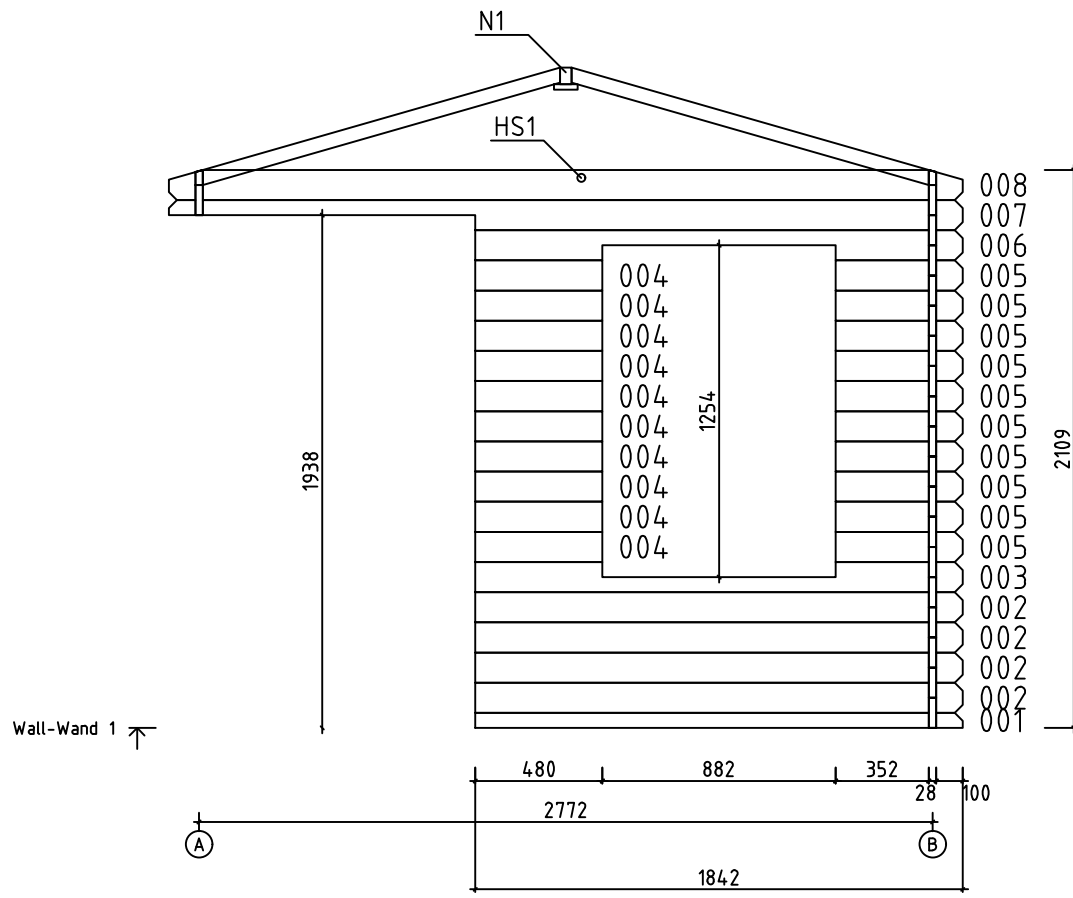

| | | | |
|----------|--------------|-------|------------------|
| Model | Asmund28-250 | Page | 5 |
| Client | | Scale | 1:20 |
| Material | 2.8x11.4 | Date | 06.11.2018 |
| Company | | File | Asmund28-250.dwg |

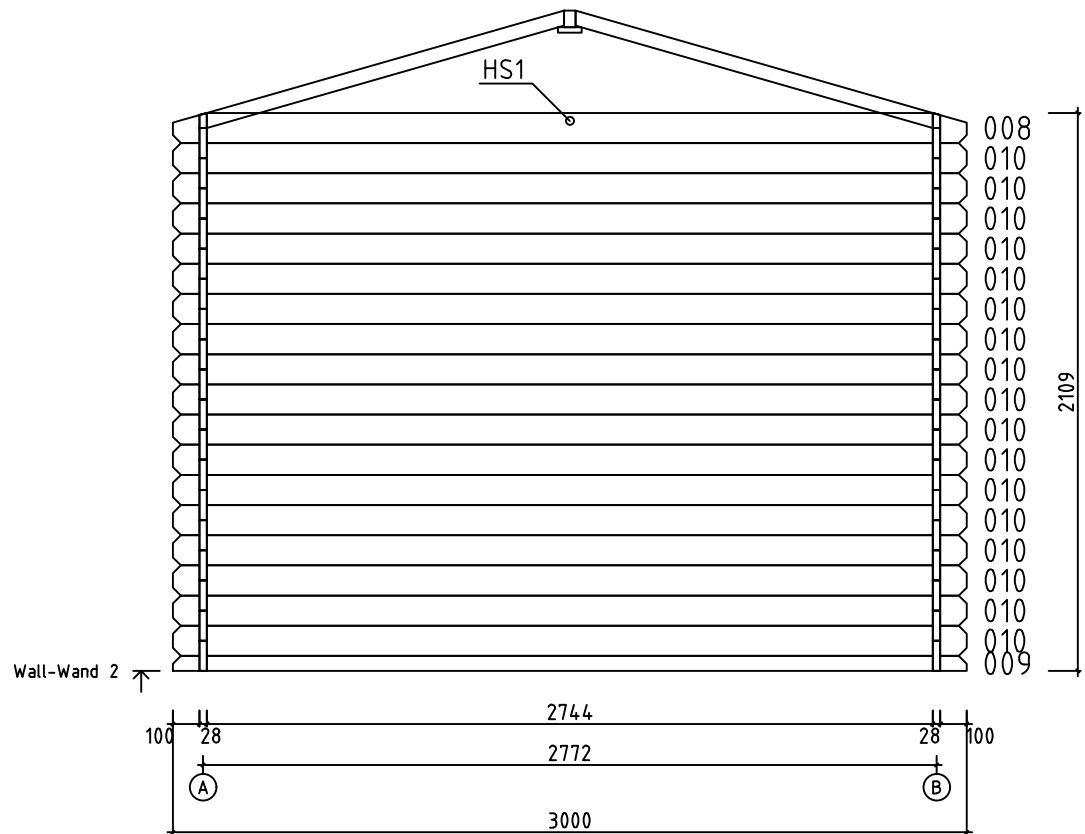

| | | | |
|----------|--------------|-------|------------------|
| Model | Asmund28-250 | Page | 6 |
| Client | | Scale | 1:20 |
| Material | 2.8x11.4 | Date | 06.11.2018 |
| Company | | File | Asmund28-250.dwg |

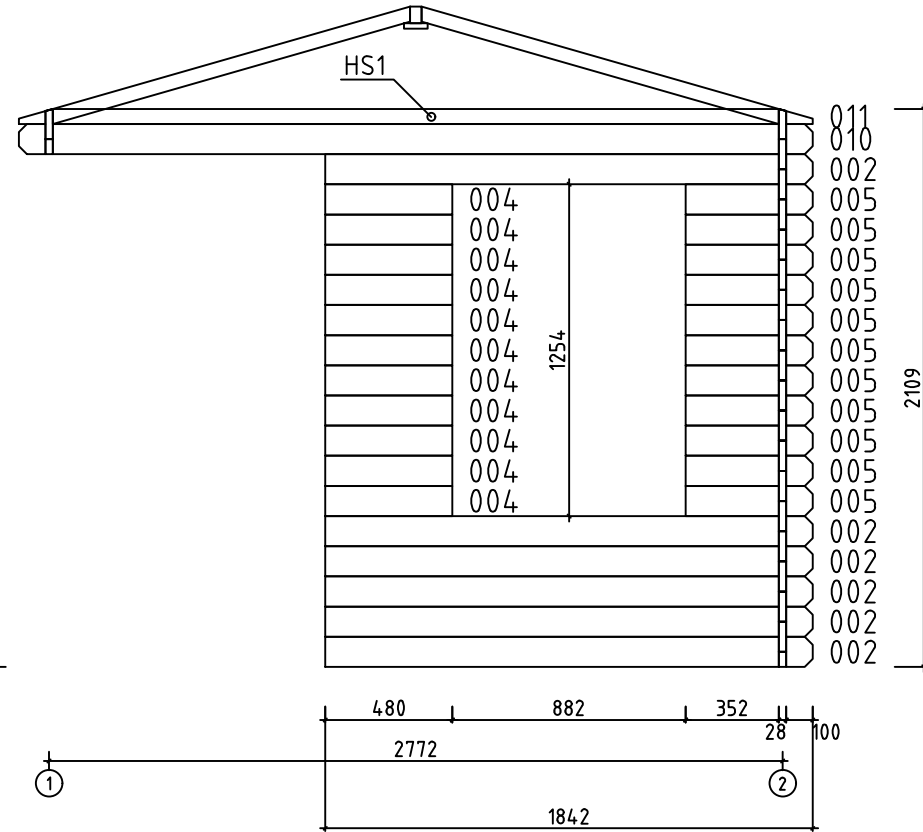

Wall-Wand A ↗

| | | | |
|----------|--------------|-------|------------------|
| Model | Asmund28-250 | Page | 2 |
| Client | | Scale | 1:20 |
| Material | 2.8x11.4 | Date | 06.11.2018 |
| Company | | File | Asmund28-250.dwg |

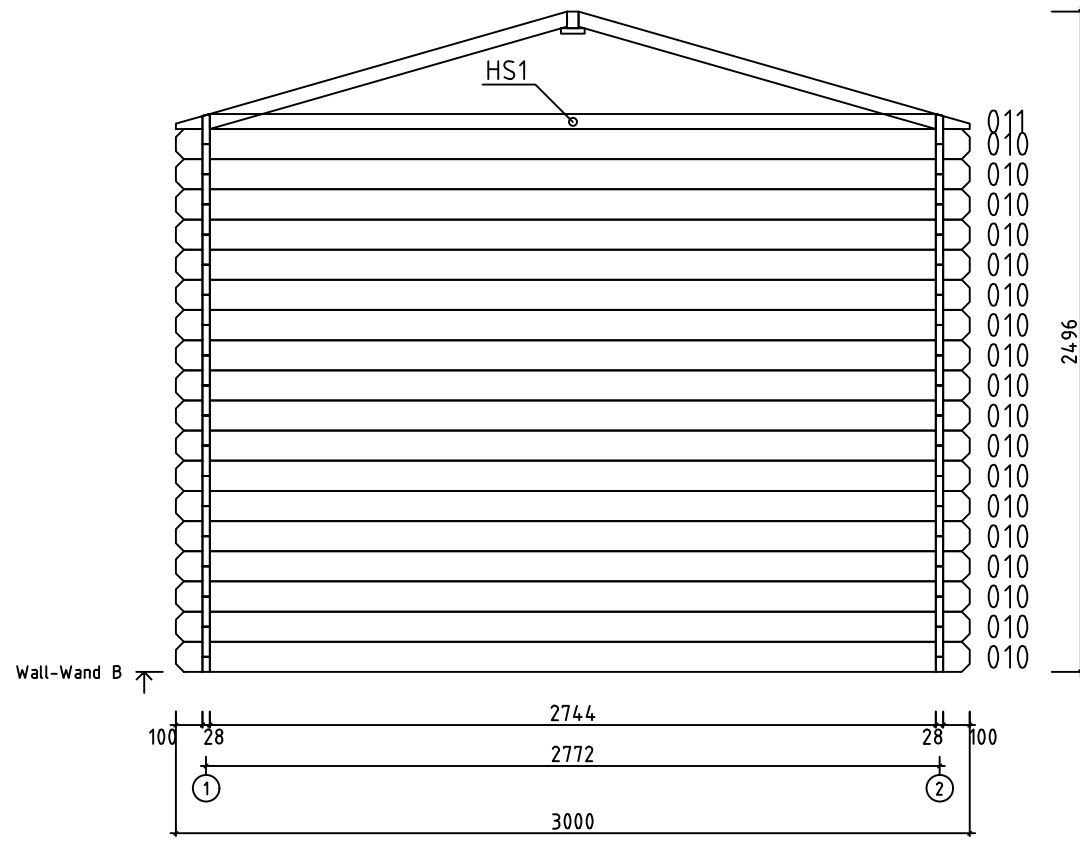

| | | | |
|----------|--------------|-------|------------------|
| Model | Asmund28-250 | Page | 3 |
| Client | | Scale | 1:20 |
| Material | 2.8x11.4 | Date | 06.11.2018 |
| Company | | File | Asmund28-250.dwg |

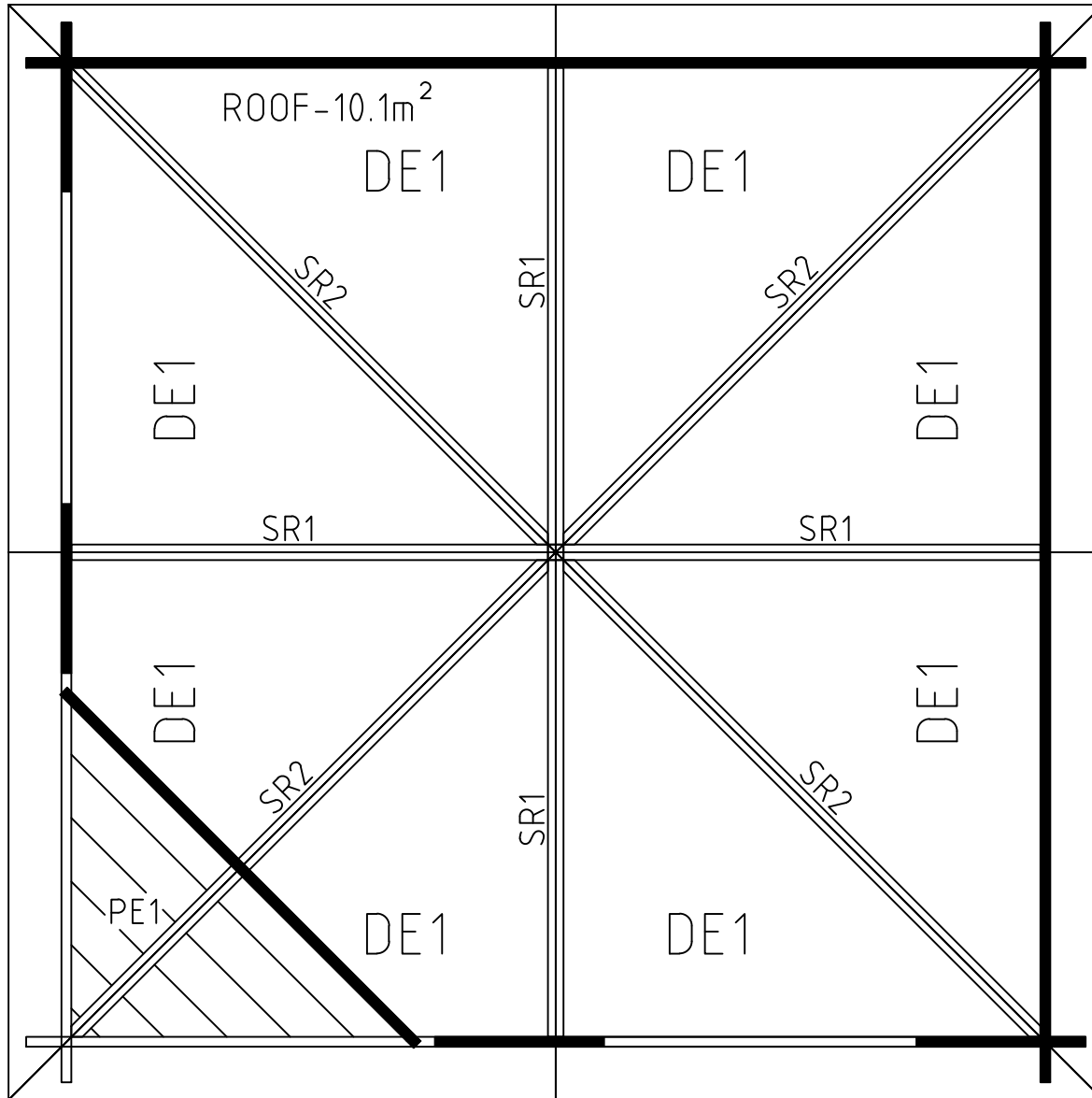

| | | | |
|----------|--------------|-------|------------------|
| Model | Asmund28-250 | Page | ROOF |
| Client | | Scale | 1:20 |
| Material | 28x114 | Date | 06.11.2018 |
| Company | | File | Asmund28-250.dwg |

The guide is illustrative. This guide is not project specification.
Der Leitfaden ist illustrativ. Dieser Leitfaden ist keine Projektspezifikation.
De gids is illustratief. Deze gids is geen projectspecificatie.

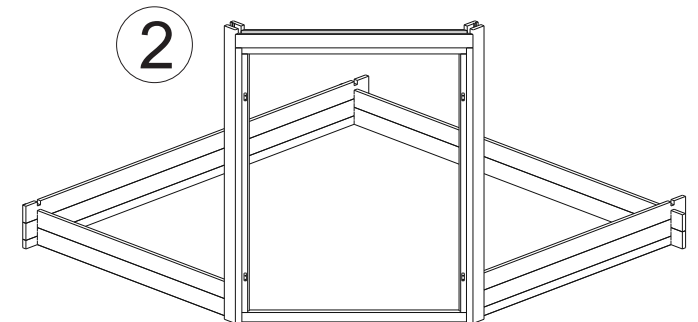
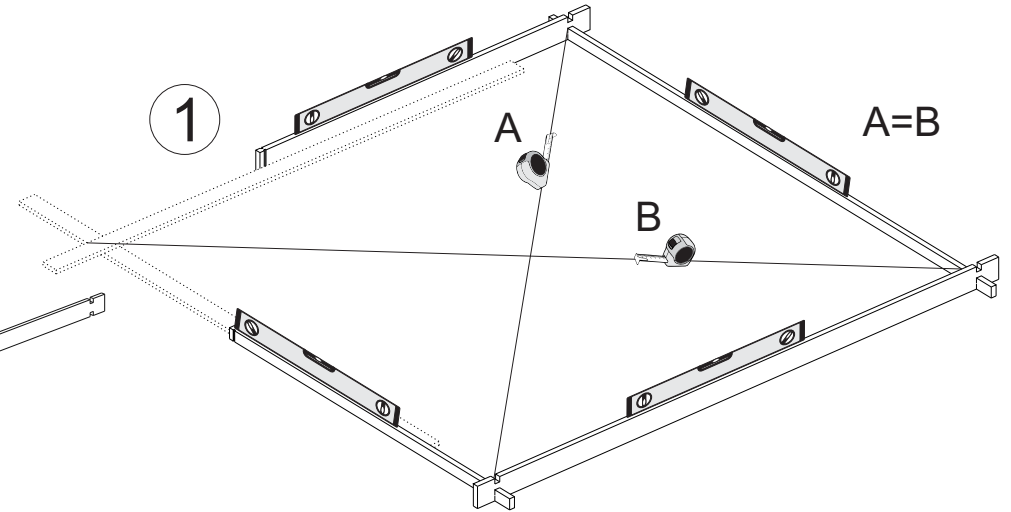
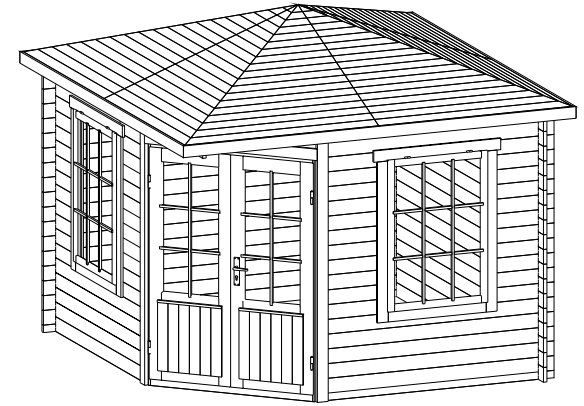
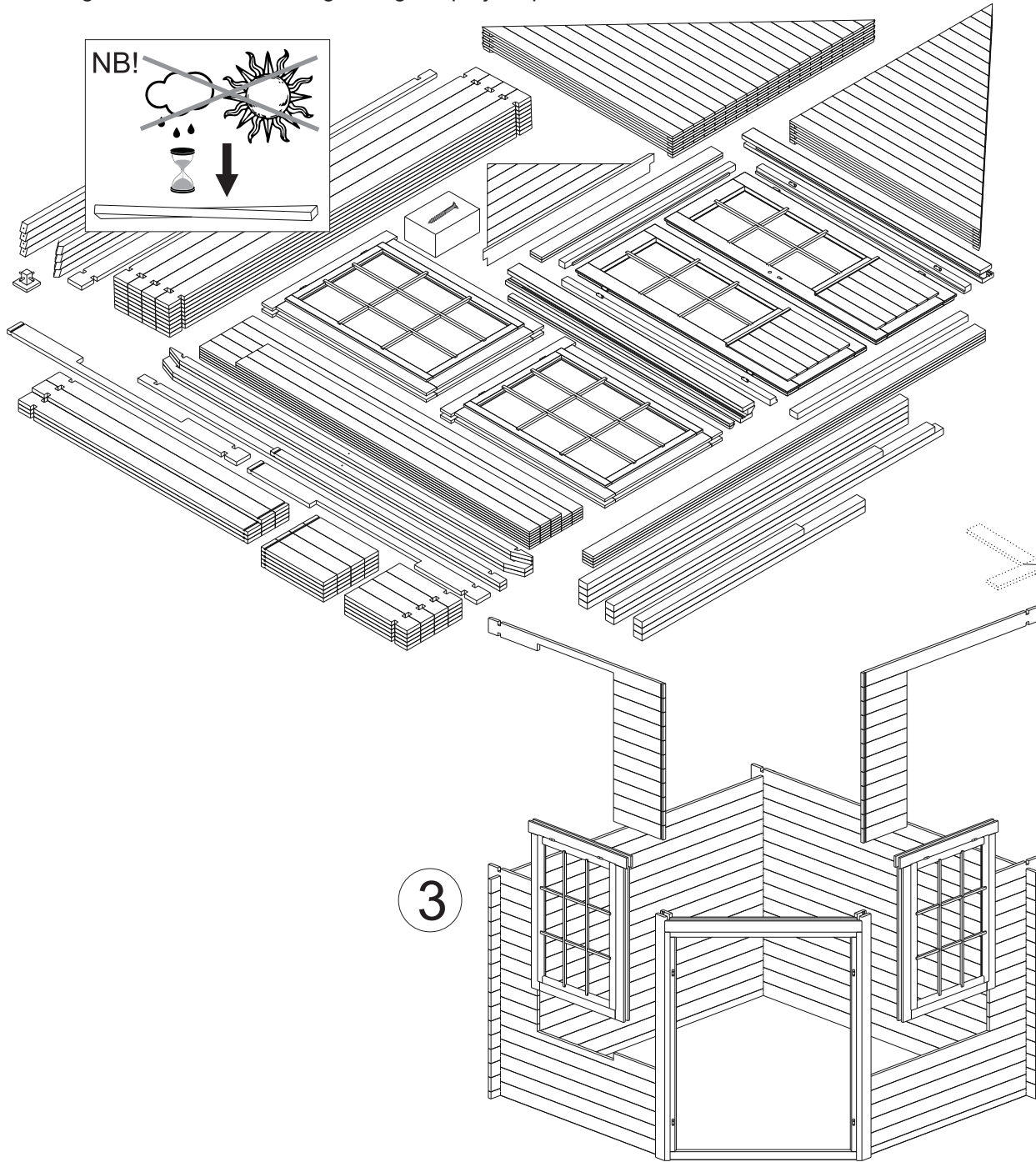

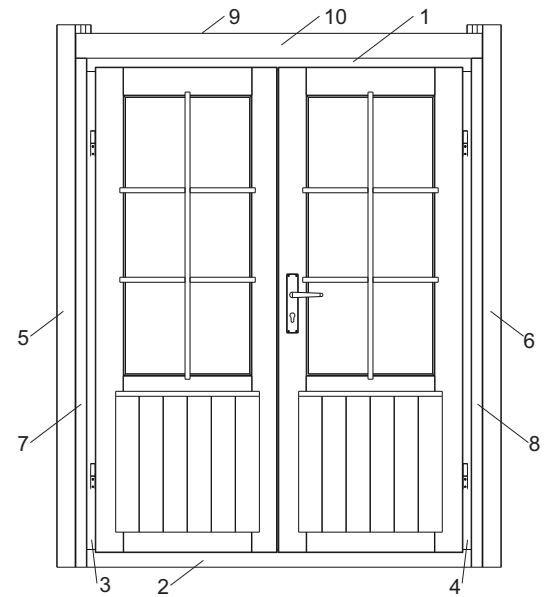
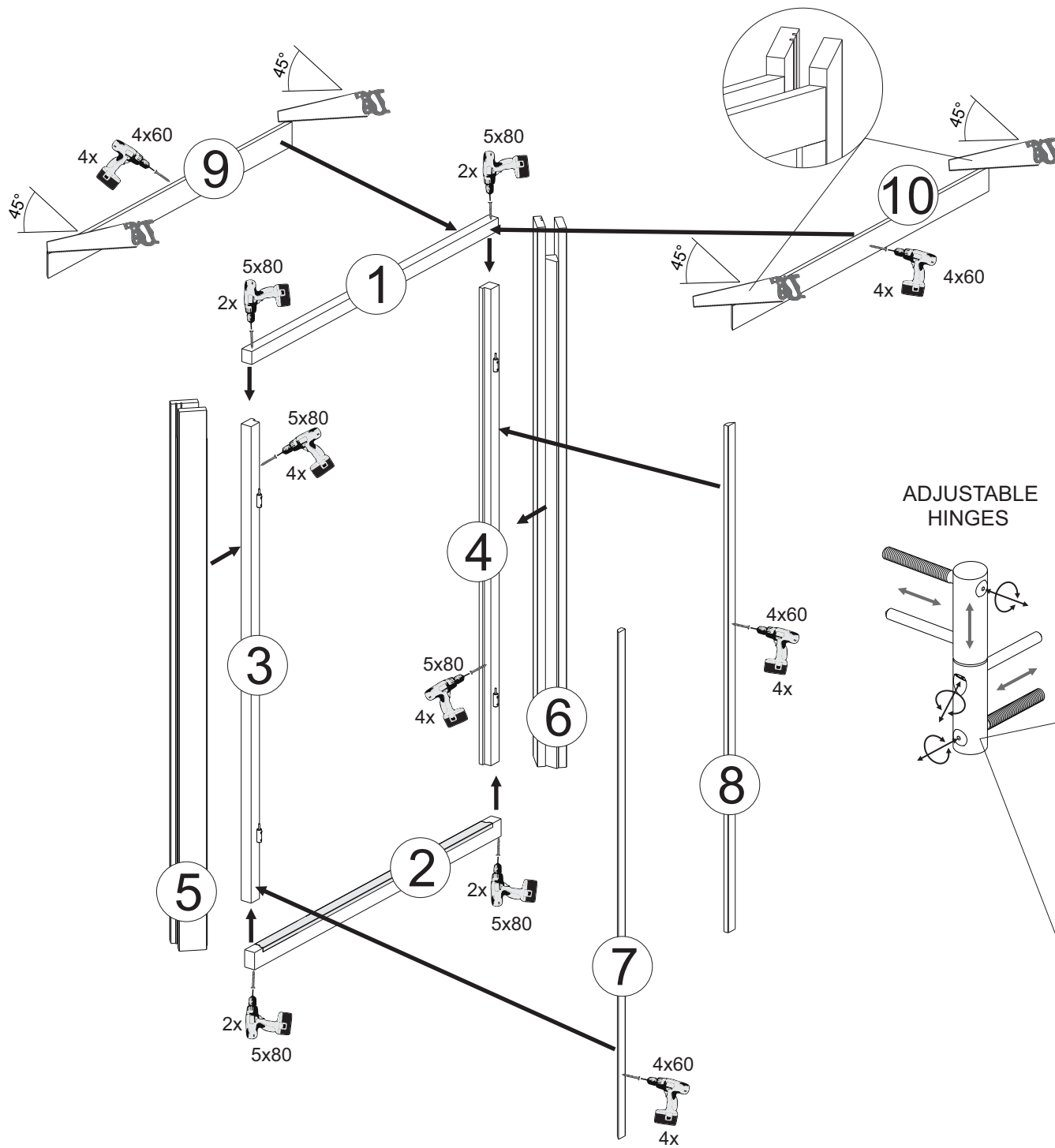

ADJUSTABLE HINGES

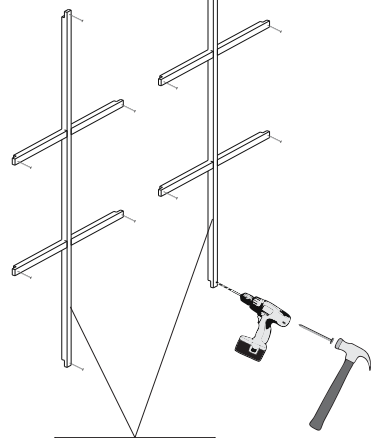
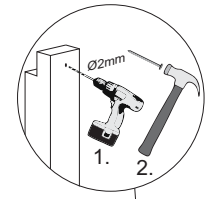
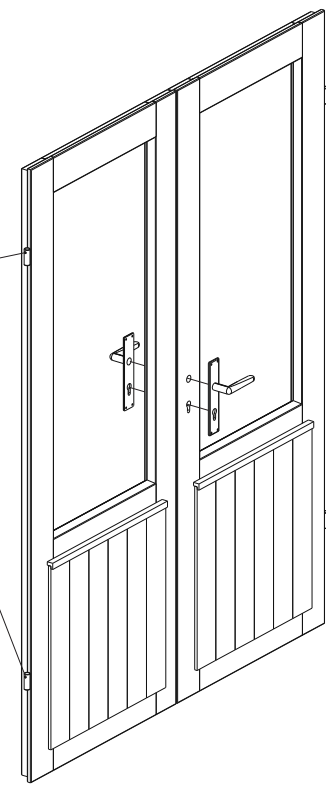
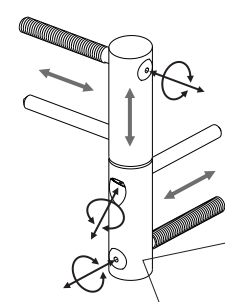

OPTIONS!

4

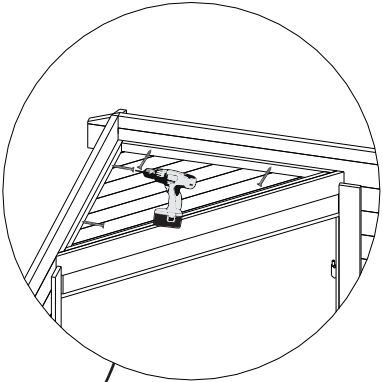
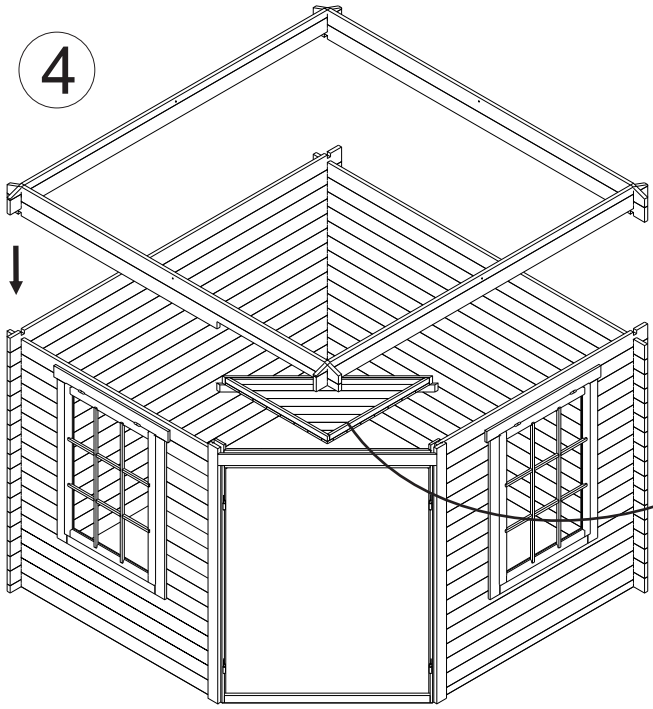

5

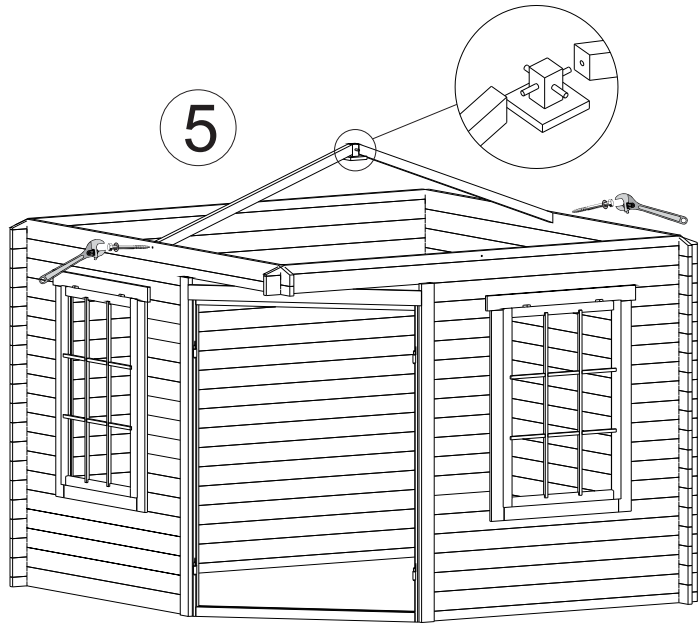

6

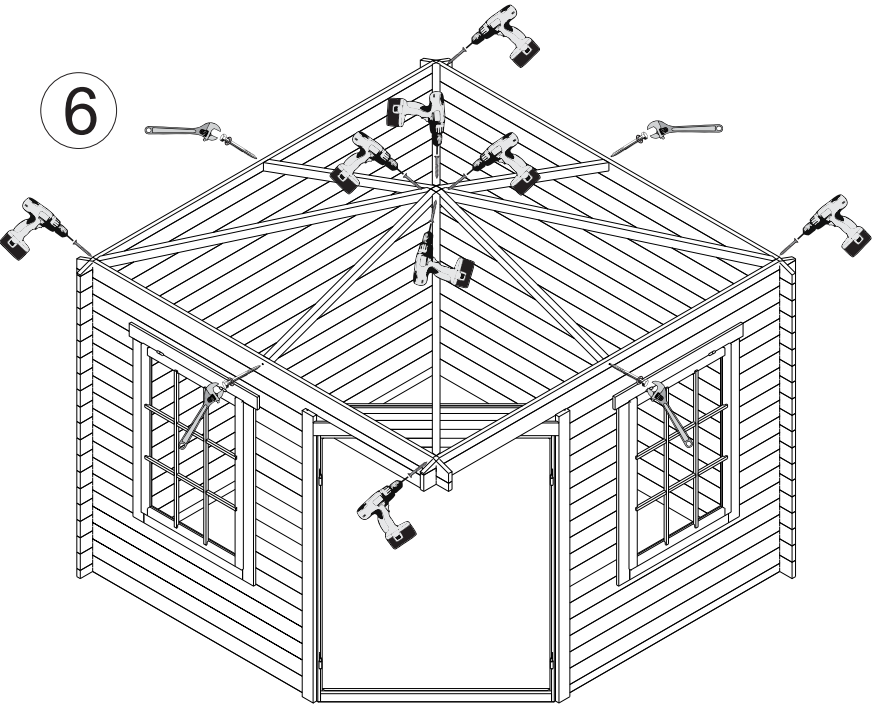

7

